



**B.Sc. Ag
II Sem**

Agricultural Microbiology

Credit - 2(1+1)

**As per ICAR
5TH Dean Syllabus**

**Download all BSc
Agriculture Notes from**
(Search on Google)

Bscagriculture.com

INTRODUCTION TO MICROBIOLOGY

Microbiology is the study of living organisms of microscopic size, which include bacteria, fungi, algae and protozoa and the infectious agents at the borderline of life that are called viruses. It is concerned with their form, structure, reproduction, physiology, metabolism and classification. It includes the study of their distribution in nature, their relationship to each other and other living organisms, their effects on human beings and on other animals and plants, their abilities to make physical and chemical changes in our environment and their reactions to physical and chemical agents.

Most **microorganisms** are unicellular in which all the life processes are performed by a single cell. All living cells contain protoplasm which is a colloidal organic complex consisting of largely proteins, lipids and nucleic acids.

DIFFERENT MICROBIAL GROUPS

The major groups of protists are briefly described below.

A). Prokaryotic Protists

1. **Bacteria:** Unicellular, prokaryotic, cell multiplication is usually by binary fission. Cyanobacteria (Blue Green Algae) is also a prokaryotic protist.

Practical significance: Cause diseases, natural cycling- soil fertility, spoil food, make food. etc.

B). Eucaryotic Protists

- 1). **Algae:** Relatively simple organisms. The most primitive are unicellular. Others are aggregations of similar cells with little or no differentiation in structure or function. Some algae such as large brown algae have a complex structure with cell types specialized for particular functions. Regardless of size or complexity, all algal cells contain chlorophyll and are capable of photosynthesis. Found in aquatic environments or in damp soil.

- 2). **Fungi:** Eucaryotic lower plants devoid of chlorophyll. They are usually multicellular but are not differentiated into roots, stems and leaves. They range in size and shape from single celled microscopic yeast to giant multicellular mushrooms and puff balls. True fungi are composed of filaments and masses of cells, which make up the body

of the organism called mycelium. They reproduce by fission by budding or by spores – molds, mildews, yeasts and rusts belong to this group.

3). **Protozoa:** Unicellular, Eukaryotic. Differentiation based on their morphological, nutritional and physiological characteristics. Best known protozoa are few that cause disease in human beings and animals.

Viruses

They are not protists or cellular organisms. But they are studied here as a) The techniques used to study viruses are microbiological in nature b) viruses are causative agents of diseases hence the diagnostic procedures for their identification are employed in clinical microbiological laboratory as well as in plant pathology lab.

They are very small non-cellular parasites or pathogens of plants, animals and bacteria as well as other protists. They can be visualized only in electron microscope. They can be cultivated only in living cells.

IMPORTANCE OF DIFFERENT MICROBIAL GROUPS:

Microorganisms occur everywhere in nature – In air, oceans, mountain tops etc. as the conditions for the growth and survival of the microorganisms are similar to those of human beings, they are in the air we breathe, and the food we eat. They are on the surface of our bodies, in our mouths, noses, alimentary tracts etc. Fortunately, most microorganisms are harmless to human beings and we have means of resisting invasion by those that are potentially harmful.

Some microorganisms are beneficial and some are detrimental. Microbes are involved in making of cheese and wine, in the production of penicillin, interferon and alcohol, in the processing of domestic and industrial wastes. They can cause disease, spoil food; deteriorate materials like iron pipes, glass lenses and wood pilings.

Late Selman A Waksman –Microbiologist observed that there is no field of human endeavor whether it may be an industry or agriculture or in the preparation of food or in connection with problems of shelter or clothing or in the conservation of human or animal health and combating of disease where the microbe does not play an important and

often dominant role. He discovered antibiotic Streptomycin produced by soil bacterium for which he got Noble Prize in 1952.

IMPORTANCE OF MICROORGANISMS:

Microorganisms have some characteristics, which make them ideal specimens for the study of numerous fundamental processes. At cellular level many life processes are performed in the same manner whether they may be in microbe, mouse or human.

1. They are the attracting models for studying the fundamental processes. They can be grown in test tubes or flask thus require less space. They grow rapidly, and reproduce at an unusually high rate. Some species undergo 100 generations in 24 hours period.
2. In microbiology we can study the organisms in great detail and observe their life processes while they are actively metabolizing, growing, reproducing, aging and dying.
3. Microorganisms have wider range of physiological and biochemical potentialities. Some bacteria can fix atmospheric nitrogen, while other species require Inorganic or Organic nitrogenous compounds for their metabolic activity.

HISTORY OF MICROBIOLOGY

The existence of microbial world was unknown until the inventions of microscopes, which were invented at the beginning of 17th century. The discoverer of the microbial world was a Dutch merchant **Antony von Leeuwenhoek** (1632-1723) with his microscope. His microscopes were able to give clear images at magnifications from about 50 to 300 diameters. Leeuwenhoek's place in the scientific history depends on the range and skill of his microscopic observations. He studied almost every conceivable object that could be looked through a microscope. He described the microbial world he observed as 'animalcules' or 'little animals'. All the main kinds of unicellular organisms that we know today – protozoa, fungi, algae, & bacteria were first described by Leeuwenhoek. He was first to describe the Spermatozoa, RBC, free living as well as parasite protozoa & the bacteria which he called animalcules (small animals). He communicated all his observations to the British Royal Society in a series of letters. Leeuwenhoek's discovery of the animalcules & other microbes revealed the presence of a hitherto unknown world – the microbial world. However, the development of study of microorganisms into science 'Microbiology' has been delayed till late 19th century. The principal reasons for this long delay seems to have been technical ones.

After Leeuwenhoek's discovery of microorganisms, the origin of microbes became the subject of discussion. Some Scientists believed that animalcules were formed spontaneously from non-living materials, whereas others (including Leeuwenhoek) believed that they were from seeds or germs of these animalcules, which were always present in the air.

Spontaneous Generation

The belief in the spontaneous formation of living beings from non-living matter is known as Doctrine of spontaneous generation (SG). This controversy existed for a long time. It became difficult to disprove this doctrine, because of lack of experimental proof.

Later **Francesco Redi** in 1665 performed experiments and showed that maggots that develop in putrefying meat are the larval stages of flies and will never develop in

putrefying meat if it is protected from flies laying eggs. He was the first to disprove SG of animals.

Lazzaro Spallanzani (1729-99) was the first to provide evidence that microorganisms do not develop spontaneously. He boiled beef broth for an hour and then sealed the flasks. No microbes appeared following incubation.

John Needham (1713-81) insisted that air was essential for SG of microbes. By sealing the flasks, the air had been excluded.

This argument was answered after 60 – 70 years independently by two other scientists.

Franz Schulze (1815-73) passed air through strong acid solutions into boiled infusions.

H.Schroder and T.Von Dusch (About 1850) passed air through cotton into flasks containing heated broth. Thus the microbes were filtered out of the cotton fibers and no microbial growth. Basic technique of plugging bacterial culture tubes with cotton stoppers was initiated.

Archimede Pouche (1859) published an extensive report favoring SG.

Louis Pasteur (1822-1895) the immortal French scientist, performed various experiments to disprove S.G. He developed a flask with a long, narrow gooseneck opening through which untreated and unfiltered air could pass in or out, but the germs settled in gooseneck. As germ free air entered the flask no microbes appeared in the infusion.

In 1862, Louis Pasteur conducted experiments to disprove the theory of Spontaneous Generation. He prepared flasks, with long, narrow, goose-neck openings heated the nutrient broth in the flask and thus the air carrying the germs were allowed to settle in the goose-neck. When the flasks were cooled, the air entering through the goose-neck retained the germs, and under these conditions the broth remained clear. He also showed by further studies that ‘used’ cotton filters, when examined under the microscope, revealed the presence of microscopic organisms.

John Tyndall (1820-1923) proved that dust carried the germs. He showed that sterile infusions placed in a dust free chamber could remain sterile indefinitely even if kept exposed to air. During his experimentation he concluded that bacteria have phases one relatively thermolabile (growing phase destroyed by boiling for 5 min.) and one thermo resistant (bacterial spores cannot be destroyed even by boiling for 5 ½ hours). He developed a method of sterilization by discontinuous heating, later called Tyndallization, which could be used to kill all bacteria in infusions. Allowed the infusion to stand for a certain period, before applying heat to permit the germination of spores with a consequent loss of their heat resistance. Then boiled to kill bacteria. He found that discontinuous boiling for 1 min on 5 successive occasions would make the infusion sterile whereas continuous boiling for 1 hr. would not.

Pasteur and Tyndall's experiments finally disproved the Doctrine of Spontaneous generation (S.G.).

ROLE OF MICROBES IN FERMENTATION

Cagnaird Latour; Theodor Schwann; F. Kutzin independently showed that microbes are involved in fermentation of sugar to alcohol.

Louis Pasteur continued his work and found that fermentation of fruits and grains, resulting in alcohol was brought out by microbes. Pasteur suggested that good quality fermented products can be obtained by selecting proper microbe. The other unfavorable microbes can be avoided by heating the fruit juice at 62.8 ° C for 30 min. This process is called Pasteurization and is widely used in fermentation industries. This short heating process kills pathogenic and spoilage microorganisms but does not sterilize the liquids completely.

During his studies on the butyric fermentation, Pasteur discovered the existence of forms of life, which can live only in the absence of free oxygen. He introduced the terms aerobic and anaerobic to designate life in the presence and absence of oxygen respectively. Pasteur described that fermentation is life without air. Some strictly anaerobic microorganisms such as the butyric acid bacteria are dependent on fermentative mechanisms to obtain energy.

Most of the organisms require oxygen to oxidize organic compounds to CO₂. Such oxygen linked biological oxidation known as aerobic respiration provides energy that is required for maintenance and growth.

Facultative anaerobes: Many other microorganisms including certain yeasts are facultative anaerobes which have two alternative pathways of energy yielding mechanisms – in the presence of oxygen they employ aerobic respiration – in the absence of oxygen, they employ fermentation.

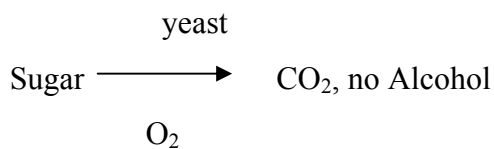
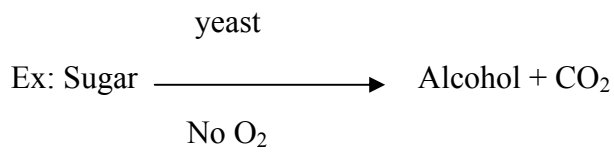

The above process was demonstrated by Pasteur. Fermentation is a less efficient energy yielding process than aerobic respiration, because the part of the energy present in the substance degraded is still present in the organic end products.

At the same time **Ferdinand Cohn** demonstrated that certain bacteria could produce spores, which are heat resistant.

GERM THEORY OF DISEASES

Von Plenciz (1762) described that living agents are the cause of disease. Different germs are responsible for different diseases in 1836

A. Bassi recognized that the fungus was the causative organism for disease in silkworm.

In 1845 **M J Berkeley** had proved that Potato Blight of Ireland was caused by fungus.

J L Schonlein showed that certain skin diseases of man are caused by fungal infections.

During this period **Pasteur** worked on silkworm disease and isolated the parasite, causing disease. Pebrine is caused by a protozoan rather than by a bacterium. He also showed that silkworm farmers could eliminate the disease by using only healthy and disease free caterpillars for breeding stock. He also worked on anthrax, a disease of cattle and sheep. He isolated the microbes from diseased animals.

Robert Koch (1876) concluded the germ theory of disease by working on anthrax disease on animals (sheep). His experiments and observations led to the establishment of Koch's postulates, which provided the guidelines to identify the causative agent of infectious diseases.

He discovered the typical bacilli with squarish ends in the blood of cattle that had died of anthrax. He grew these bacteria in cultures in his laboratory, examined them microscopically to be sure he had only one kind present, & then infected them into other animals to see if these became infected & develop clinical symptoms of Anthrax.

From these experimentally infected animals he isolated microbes like those he had originally seen that died of Anthrax

This was the first time a bacterium had been proved to be the cause of an animal disease.

This series of observations led to the establishment of Koch's postulates – which provided guidelines to identify the causative agent of an infectious disease.

Koch's Postulates:

- a). The microorganism must be present in every case of the disease.
- b). The microorganism must be isolated from the diseased host and grown in pure culture.
- c). The specific disease must be reproduced when a pure culture of microorganism is inoculated into a healthy susceptible host.
- d). The microorganism must be recoverable once again from the experimentally infected host.

He also demonstrated the biological specificity of disease agents. These developments led to the creation of institutions both in Paris for Pasteur and in Berlin for Koch. Pasteur's group concentrated on how the recovery and immunity are brought about in diseased animal whereas Koch's group conducted experiments on the etiology of major infectious diseases.

PURE CULTURE METHODS

O. Brefeld introduced the practice of isolating single cells of fungi and their cultivation on solid media, which were obtained by adding gelatin to the liquid medium. His methods were not suitable for bacteria.

Pure cultures of bacteria were 1st obtained by **Joseph Lister** by serial dilution in liquid media. *Bacterium lactis* was isolated into pure culture in this method. In 1864 **Joseph Lister** developed antiseptic method of surgery.

Koch developed pure culture technique for bacteria. He developed streak plate method and Pour plate method for this purpose. At first, Koch experimented with the use of sterile cut surfaces of potatoes which he placed in sterile covered glass dishes & then inoculated with the bacteria. The cut surfaces of potatoes had disadvantages firstly moist surface allowed motile bacteria to spread, secondly the substrate was opaque & examination of bacterial colonies is difficult.

Later Koch thought that if a liquid medium could be solidified by the addition of a solidifying agent such as gelatin. Koch Poured the molten gelatin medium on glass plates & allowed to solidify. After solidification the surface was streaked with a cotton swab dipped into bacterial suspension & then Growth was found along the streak & single colonies were found at the end of the streak.

Although gelation was useful as a solid base in media, it had certain disadvantages.

1. It is a protein that is susceptible to microbial digestion
2. A change from gel to a liquid occurs at a temperature of about 28⁰C while for most bacteria an incubation temperature of 30-37⁰C is optimum

With the help of his colleague **Dr. Hesse**, he replaced the solidifying agent gelatin (Protein) with agar (a complex polysaccharide obtained from red algae) which melts at 98° C and solidifies at 44° C. Agar is a complex polysaccharide extracted from the red algae is not easily degraded by most bacteria. For these reasons agar quickly replaced gelatin as a hardening agent. Koch developed nutrient broth & its solid counter part nutrient agar. Koch also developed the nutrient medium for the growth of bacteria.

BELJERINCK and WINOGRADSKY

- They developed the technique of ‘Enrichment culture’
- By modifying the composition of the medium or incubation conditions it is possible to isolate or specific organisms from a mixed population.
-

Francois Appert found that highly perishable foodstuff can be preserved for long time by enclosing them in airtight containers and heating the containers. This process is known as Appertization and is the principle of food canning.

SCHRODER AND VON DUSCH passed air through cotton into flasks containing heated broth. Thus the microbes were filtered out from the air by the cotton fibers so that growth did not occur & a basic technique of plugging bacterial culture tubes was initiated.

JOHN TYNDALL concluded that some microorganism exist in two forms that is - a heat labile form (Vegetative) & heat resistant form (endospores). He developed a method of sterilization by discontinuous heating, called **Tyndallisation**. Which could be used to kill all bacteria in infusions

PROTECTION AGAINST INFECTION:

Edward Jenner in 1798 used Cowpox Virus to immunize people from small pox. But the science behind this technique was not known at that time.

Frederick Loeffler (1884) discovered Diphtheria bacillus and demonstrated the production of toxin in lab flasks.

Behring and Shibasaburo Kitasato devised a method of immunity by introducing their toxins into animals so that an antitoxin would develop. Behring made antitoxin for tetanus. He received Noble Prize in 1901 for his work on serum therapy.

Pasteur isolated the bacterium responsible for chicken cholera and grew it in pure culture. He has taken two batches of chickens and he inoculated one batch with attenuated cultures (cultures of several weeks old) and the other batch with virulent (fresh culture) cultures. The batch that was inoculated with attenuated cultures developed resistance and the other batch died. He termed these attenuated cultures as Vaccines. Attenuated cultures stimulated hosts to develop antibodies. Pasteur later used this technique to prevent anthrax.

Pasteur's fame was well known through out France and was asked to work on human disease 'Rabies' (Viral disease due to mad dog). He worked on it and prepared Vaccine to rabies.

Elie Metchnikoff described how certain leukocytes (white blood cells) could ingest (eat) disease producing bacteria. He called these special defenders against infection as Phagocytes (eating cells) and the process 'Phagocytosis', which is the first and most important defence against infection.

Paul Ehrlich first discovered the Chemotherapeutic substance.

1880-1900 was the golden period for microbiology.

Another golden era of microbiology started about 1945 with foundation of modern biology i.e. Molecular Biology laid with the knowledge gained with different microorganisms

APPLIED AREAS OF MICROBIOLOGY:

Microorganisms occur in natural environments and bring about many desirable and undesirable changes. Beneficial microbes are more than the harmful ones. The diversity of their activities ranges from causing diseases in human, animals and plants to the production and deposition of the minerals, the formation of coal and enhancement of soil fertility. The important areas are:

Agricultural Microbiology

Discoveries like that of Pasteur and Koch were almost immediately applied to Agriculture and other areas.

Sergei Winogradsky, a Russian scientist showed the importance of bacteria in taking nitrogen from atmosphere and making it available as plant food and hence as animal food. This discovery opened the field of Soil Microbiology in late 1800's. In 1880 H. Hellriegel and H. Wilfarth showed the symbiotic relationship between bacteria and leguminous plants. William Beijerinck (1851-1931) discovered the *Azotobacter*, a free-living bacterium that can fix atmospheric nitrogen and improves the soil fertility. Beijerinck and Winogradsky also developed a technique of "Enrichment culture".

These two scientists described the role of microorganisms in transformation of mineral nutrients in soils and led to the development of nitrogen and sulphur cycles. The discovery of T J Burrill that a disease known as Fire Blight in pears was caused by bacterium led to the development of plant pathology.

Chamberland in 1884 developed porcelain filters that allow passage of fluid but not bacteria. Using these bacterial filters, Iwanowski in 1892 found that the filtrate obtained from Tobacco plants infected with mosaic disease was fully infectious to healthy plants.

Beijerinck confirmed the above observations and named the disease-causing agent as "Virus" (infectious poisonous agent) and showed that this tobacco mosaic virus (TMV)

could be propagated within the living host. Loeffler and Frosch were the first to show that there were filterable agents, which could be transmitted from one infected animal to another.

W.M. Stanley and J.H. Northrup in 1935 isolated the TMV in crystalline form and described the nature of virus for which they got the Noble Prize in 1946. F.W. Twort (1915) and F.D. Herelle (1917) independently discovered the bacteriophages viz., the viruses that kill the bacteria.

Industrial Microbiology

The discovery that microorganisms bring about chemical transformations led to the search for microorganisms that produce a variety of chemicals. In 1893 Wehmer used fungi for the production of citric acid. Fleming in 1929 discovered that fungi produce antibiotics and it was the beginning in understanding of chemotherapy and control of infectious diseases by the use of microbial products. Penicillin was identified as a product of *Penicillium*, which led to the search and development of a variety of antibiotics from microorganisms such as fungi and Actinomycetes. S A Waksman (1888-1973) showed that Actinomycetes are prolific producers of a variety of antibiotics. Isolation of various regulatory mutants of microorganisms to produce various chemicals has revolutionized the industrial processes. Various scientists used pure cultures known as “Starters” for the manufacture of cheese, butter, and vinegar and in fermentation industries.

It involves the study of Production of medicinal products such as antibiotics and vaccines, fermented beverages, industrial chemicals, production of proteins and hormones by genetically engineered microorganisms.

Medical Microbiology

Causative agents of disease- diagnostic procedures for identification of causative agents; Preventive measures. Bacteria, fungi and viruses cause several diseases in plants, animals and human beings. This branch deals with isolation and identification of causative organisms from samples using different diagnostic procedures. It also deals with the steps required for prevention of different diseases and chemicals used for controlling causative organisms.

Food Microbiology

Deals with food spoilage, food preservation, food borne diseases and their prevention and food fermentations due to the growth conditions required are similar to human beings and several heterotrophic microorganisms. They grow on food and spoil, and some microbes ferment foods which are useful to human beings. This branch also deals with extrinsic and intrinsic parameters of food which determines the type of spoilage by microorganisms. Different methods are available for different foods.

Pollution Microbiology

The remedial measures to remove the ill-effects of pollutants on the environment by biological means constitute Bioremediation. The environment becomes sick when it is burdened or over loaded of difficultly degradable mass produced through human activities. The efforts to remove such unhealthy conditions through biological agencies is referred as bioremediation. This can be achieved either by creating conditions which encourage acceleration of biodegradation by biological organisms at polluted site, or by new organisms which are more efficient. Such new organism may be selected from nature or may be created in the lab by genetic manipulation.

- Genetically engineered strain of *Pseudomonas putida* is highly effective in degrading crude petroleum. *Pseudomonas cepacia* is used for removal of chlorinated hydro carbons from effluents of pesticide manufacturing plants

Aero Microbiology

Air has no resident micro flora as water & soil has nevertheless, air generally has different microorganisms viruses, bacterial & fungal spores, pollen of angiosperms & gymnosperms, various spores of lower plants. Microbial content of air depends on the location. Most of the organisms present in air come from soil but pathogenic organisms & viruses may originate from diseased persons, particularly those suffering from droplet infections. This field deals with biological objects in air & the effects on biological systems.

Geo Chemical Microbiology

Deals with coal, mineral and gas formation, prospecting for deposits of coal, oil, and gas, recovery of minerals from low-grade ores. The possibility of extracting metals from low-grade ores through microbial activities has been explored. The sulfuric acid producing bacteria specially, *Thiobacillus thiooxidans* & *T. ferrooxidans* have been found to be capable of recovery of copper & uranium from low grade ores of these metals. This process is known as bioleaching of metals.

Bioleaching is more ecofriendly & it occurs at ordinary temperature & pressure without emission of pollutants

Aquatic Microbiology

Deals with methods of water purification, microbiological examination of water samples, microbiological standards for different types of water.

Exo Microbiology

It deals with Exploration for life in outer space.

Microbial Biotechnology

Microbial Biotechnology has been defined as the scientific manipulation of living organisms, especially at molecular genetic level to produce useful product. An important way of such manipulation is import a gene of choice from a donor to a prospective producer through a vector to produce a transgenic organisms. If the imported gene survives & functions properly to produce the gene product, the recipient organism commonly a bacterium or yeast, can be mass-cultured to obtain the product on commercial basis.

It should be understood that microbial biotechnology differs from traditional industrial Microbiology mainly in the development of a producing organism. Once this is achieved through application of modern molecular genetic techniques, the cultivation of the producing organisms, product recovery etc are done as in fermentations. For eg: Insulin a small polypeptide hormone used for diabetics, has been traditionally extracted from pancreas of slaughtered animals. The two human genes encode the 2 polypeptide chains have been cloned in *E. coli* & *Saccharomyces* & the hormone can now be obtained

by fermentation of these transgenic organisms. Other products like, blood - coagulation factor XIII, hepatitis B virus antigen, HIV -1 antigen, (α) L-antitrypsin are now obtained from transgenic *S. cerevisiae*.

Lecture – 5

REVIEW OF BACTERIAL CELL STRUCTURE:

Until the eighteenth century all the living organisms were grouped into two kingdoms, plant and animal. After the discovery of the microbial world, it is evident that some organisms are predominantly plant like, some are animal like and some others share the characteristics common to both plants and animals. Since there are organisms that do not fall into either plant or animal kingdom, it was proposed that new kingdom be established to include those organisms, which typically are neither plants nor animals. E.H. Haeckel in 1866 proposed a third kingdom 'Protista' to include the microorganisms that are typically neither plants nor animals. Bacteria, algae, fungi and protozoa are included in Protists (Viruses are not cellular organisms and hence not classified as protists). Bacteria are referred to as lower protists, whereas the fungi, algae and protozoa are called higher protists.

PROCARYOTIC AND EUKARYOTIC CELLS

With the aid of electron microscopy in 1940's it was discovered that in some cells, for example typical bacteria, the nuclear substance was not enclosed by a nuclear membrane. In other cells such as typical fungi, algae, and protozoa the nucleus was enclosed by a membrane. This discovery led to the distinction of microbes into two groups *viz.*, prokaryotes (incipient nucleus) and eukaryotes (true nucleus). Bacteria are prokaryotic microorganisms and are called as prokaryotes. Algae, fungi and protozoa are eukaryotic microorganisms and are referred as eukaryotes (plant and animal cells are also eukaryotic). The eukaryotic cells are characterized by the presence of multiplicity of unit membrane systems, which are structurally and topographically distinct from cytoplasmic membrane. These membrane systems enable the segregation of different eukaryotic cytoplasmic functions into specialized organelles. The major differences between procaryotic and eucaryotic cells are detailed below.

DIFFERENCES BETWEEN PROCARYOTIC FROM EUCARYOTIC CELLS

FEATURE	PROCARYOTIC CELLS	EUCARYOTIC CELLS
I.Groups where found as unit of structure	Bacteria	Algae, fungi, protozoa, plants and animals.
II.Size range of organism	1-2 by 1-4 μm or less	Greater than 5 μm in width or diameter.
III.Genetic system location	Nucleoid, chromatin body or nuclear material	Nucleus, mitochondria, chloroplasts.
IV.Structure of nucleus	<p>-Not bounded by nuclear membrane, one circular chromosome.</p> <p>-Chromosome does not contain histones; no mitotic division.</p> <p>-Nucleolus absent; functionally related genes may be clustered.</p>	<p>-Bounded by nuclear membrane; more than one chromosome.</p> <p>-Chromosomes have histones; mitotic nuclear division.</p> <p>-Nucleolus present; functionally related genes not clustered.</p>
V.Sexuality	Zygote nature is merozygotic (partial diploid)	Zygote is diploid.
VI. Cytoplasmic nature and structures:		
1.Cytoplasmic streaming	Absent	Present
2.Pinocytosis	Absent	Present

3. Gas vacuoles	Can be Present	Absent
4. Mesosome	Present	Absent
5. Ribosomes	70S, distributed in the cytoplasm 50S + 30S	80S arrayed on membranes as in endoplasmic reticulum; 70 S in mitochondria and chloroplasts 60S + 40S
6. Mitochondria	Absent	Present
7. Chloroplasts	Absent	May be Present
8. Golgi structures	Absent	Present
9. Endoplasmic reticulum	Absent	Present
10. Membrane bound (true) vacuoles	Absent	Present
VII. Outer cell structures		
1. cytoplasmic membranes	Generally do not contain sterols, contain part of respiratory and in some, photosynthetic machinery.	Sterols present do not carry out respiration and photosynthesis.
2. Cell wall	Peptidoglycan (murein or mucopeptide) as component	Absence of peptidoglycan.
3. Locomotor organelles	Simple fibril	Multifibrilled with '9+2' microtubules.

4.Pseudopodia	Absent	Present in some.
VIII.Metabolic mechanisms	Wide variety; particularly that of anaerobic energy yielding reactions; some fix nitrogen gas; some accumulate poly-β – hydroxy butyrate as reserve material.	Glycolysis is the pathway for anaerobic energy yielding mechanism.
IX.DNA base ratios as moles % of guanine + cytosine (G +C%)	28 to 73%	About 40%

MORPHOLOGICAL TYPES OF BACTERIA:

Knowledge of the morphology and internal structure of bacteria will be useful in classifying the bacteria and also to understand various physiological processes that are taking place in bacteria.

SIZE:

0.5 to 1.0 μm in diameter, surface area/ volume ratio is exceedingly high favoring unusually high rate of growth and metabolism of bacteria. No circulatory mechanism is needed to distribute the nutrients that are taken in, due to this high surface to volume ratio.

SHAPE AND ARRANGEMENT:

The shape of bacterial cell is governed by rigid cell wall. They may be spherical (Coccus – Cocci), straight rods (Bacillus – Bacilli), or rods that are helically curved (Spirillum – Spirilli) or they may be pleomorphic (exhibit a variety of shapes).



monstrous microbe



Epulopiscium Budding & Appendaged bacteria

The Cocci are further grouped into Diplococci, Streptococci, Tetrads and Staphylococci based on the characteristic arrangement of the cells. Bacilli are mostly singular or in pairs (Diplococci). But some species may be Streptobacilli (Ex: *Bacillus subtilis*) or trichomes (Ex: *Beggiatoa*) or may have palisade arrangement (*Corynebacterium diphtheria*). Some other bacilli may form long, branched multinucleated filaments called hyphae, which collectively form mycelium (Ex: *Streptomyces*)

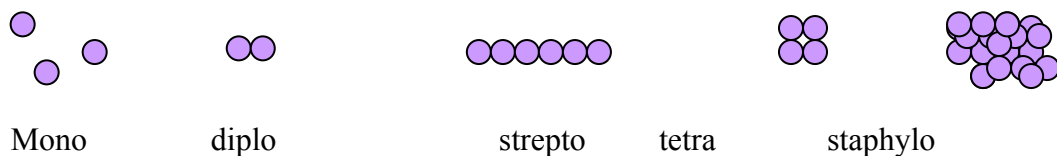

Mono

diplo

strepto

tetra

staphylo

The bacteria with less than one complete twist or turn have ‘vibroid’ shape, whereas those with one or more complete turns have a helical shape. Many other shapes also occur in addition to the above common shapes.

The cell wall is common to all bacteria. The structures that are present external and internal to the cell wall are not common to all bacteria. Some characters are more specific to certain species.

TYPICAL BACTERIAL CELL STRUCTURE AND FUNCTIONS OF DIFFERENT PARTS OF BACTERIAL CELLS

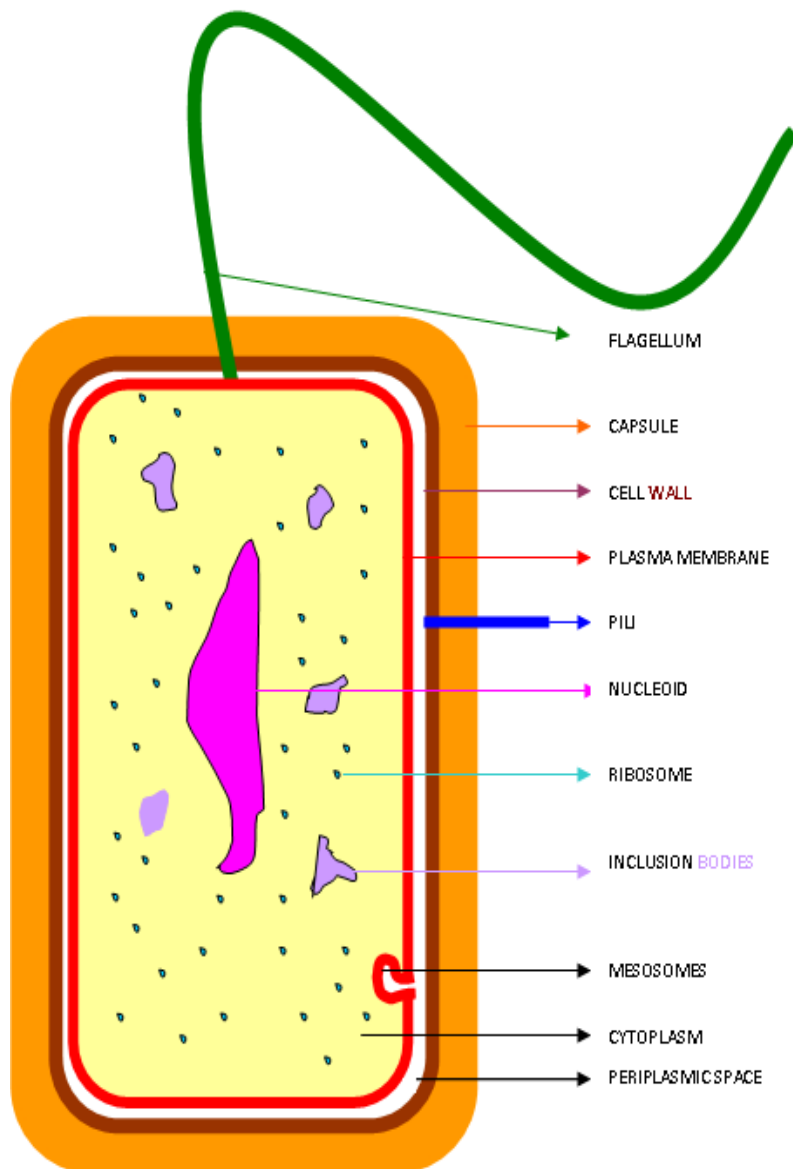

EXTERNAL STRUCTURES

Flagella (flagellum) and motility:

Bacterial flagella are hair like helical appendages that protrude through the cell wall and are responsible for swimming motility. It grows at the tip unlike hair, which grows at the bottom.

A flagellum is composed of 3 parts

- a). Basal body associated with cytoplasmic membrane and cell wall
- b). a short hook and c). A helical filament which is usually several times longer than the bacterial cell. The hook and filament are made up of protein whereas the composition of basal body is not known. The protein of the filament is known as flagellin.

Flagellar arrangement may be a). Monotrichous – a single polar flagellum b). Lophotrichous – a cluster of polar flagella c). Amphitrichous – flagella either single or clusters, at both cell poles and d). Peritrichous –surrounded by lateral flagella. Bacteria propel themselves by rotating their helical flagella. Without external flagella some helical bacteria (spirochetes) exhibit swimming motility by means of Endoflagella (flagella like structures beneath the outer cell envelope). Some bacteria ex: myxobacteria exhibit gliding motility only when they are in contact with solid surface.



Most motile bacteria are able to change their movement in response to environmental stimuli. These are called tactic movements. Bacterial chemotaxis is the movement of bacteria toward or away from the chemical compounds. Swimming of bacteria towards a chemical is known as positive chemotaxis, swimming away is negative chemotaxis. Phototrophic bacteria exhibit positive phototaxis toward increasing light intensities and are repelled by decreasing light intensities.

Pili (Fimbriae):

They are hollow non-helical filamentous appendages that are thinner, shorter and more numerous than flagella. Do not function in motility. Different types of pili have different functions.

F – pilus (Sex pilus) serves as the port of entry of genetic material during bacterial mating. Some pili play major role in human infection.

Capsule:

Many bacteria synthesize organic exopolymers that form an envelope outside the cell wall. If this layer can be seen by light microscopy using special staining methods it is called a capsule. It is termed a microcapsule if it is too thin to be seen by light microscopy. The material is called “Slime” if the layer is abundant and many cells are embedded in a common matrix. Most pathogenic bacteria produce either capsule or slime. The functions of the capsule depend on bacterial species (1) they may block attachment of bacteriophages (2) they may be antiphagocytic (3) they may provide protection against temporary drying by binding water molecules (4) they may promote attachment of bacteria to surfaces.

Sheaths:

Sheath is a hollow tube formed in some species of bacteria to enclose chains or trichomes of bacterial cells. Sheath is commonly found in the species from fresh water and, marine environments.

Cell wall composition:

In bacteria the cell wall is very rigid and gives the shape to the cell. Most of the bacteria retain their original cells even after subjected to very high pressure or severe physical conditions. It accounts for 10-40% of dry weight of the cell. Cell walls can be broken by sonic or ultrasonic treatment or by subjecting the cells to extremely high pressure and subsequent sudden release of pressure.

Cell wall composition of eubacteria is different from that of archaebacteria (bacteria are broadly distinguished into eubacteria and archaebacteria based on their ancestral relationships i.e., on evolution and genetic relatedness). Eubacteria cell wall is made up of peptidoglycan (murein and insoluble, porous cross linked polymer of enormous strength and rigidity. Peptidoglycan is basically a polymer of N-acetylglucosamine, N-acetylmuramic acid, L-alanine, D-alanine, D-glutamate and a diamino acid. The peptidoglycan is present only in prokaryotes. The cell walls of archaebacteria are generally made up of proteins, glycoproteins or polysaccharides. Gram positive and Gram negative type of bacteria are present in both eubacteria and archaebacteria.

Gram staining is one of the most important and widely used differential staining introduced by Christian Gram in 1884. Bacteria stained by Gram's staining method fall into two groups –Gram positive, (which appear deep violet in color) and Gram negative (which appear red in color). Gram staining is generally not applicable to other microorganisms. However, yeasts consistently stain gram positive.

Differences in the cell wall of Gram positive and Gram negative eubacteria

CHARACTER	GRAM POSITIVE	GRAM NEGATIVE
1. Thickness	-Thicker wall (20 – 25nm)	-Thinner (10-15 nm)
2.Layers	-A single thick. layer	Two layers (a Peptidoglycan layer and outer membrane).
3.Peptidoglycan	Account for 50% dry weight of cell wall	Only about 10% of cell wall.
4.Other constituents	Polysaccharides and Techoic acids	Outer membrane is rich in phospholipids, proteins or lip polysaccharides. Peptidoglycan layer is linked to outer –membrane by Braun's lipoprotein.
5. Susceptibility to	More susceptible	Less susceptible
a) Penicillin	Less susceptible	More susceptible
b) Mechanical disintegration		

STRUCTURES INTERNAL TO CELL WALL

Cytoplasmic membrane:

This is about 7.5 nm thick and is immediately beneath the cell wall. This is primarily composed of phospholipids (20-30%) and proteins (60-70%). This membrane contains various enzymes involved in respiratory metabolism and in the synthesis of capsular and cell wall components. It is the site of generation of proton motive force, which drives ATP synthesis, certain nutrient transport systems and flagellar motility. Damage to this membrane may result in the death of the cell.

Protoplast and Sphaeroplast:

A protoplast is that portion of a bacterial cell consisting of the cytoplasmic membrane and the cell material bound by it. This can be prepared from Gram positive bacteria by treating the cells with an enzyme such as lysozyme, which selectively dissolves the cell wall or by culturing the bacteria in the presence of an antibiotic such as penicillin.

Sphaeroplast is a protoplast surrounded by the outer membrane of cell wall. In gram-negative bacteria only peptidoglycan layer can be removed but outer membrane is still intact surrounding the protoplast.

Mesosomes:

In many bacteria, especially Gram-positive bacteria, the cytoplasmic membrane appears to be infolded at more than one point. Such infoldings are called mesosomes. Mesosomes are thought to be involved in DNA replication, cell division and export of exocellular enzymes.

Cytoplasm:

The major cytoplasmic contents of bacterial cell include the nucleus, (without a membrane), ribosomes, proteins and other water soluble components and reserve materials. In most bacteria extra chromosomal DNA (Plasmid DNA) is also present.

Bacterial Chromosome:

The bacterial nucleus is not enclosed in a defined membranous structure. The nuclear material is generally confined to the center of the cell. It consists of single circular double stranded DNA molecule in which all the genes are linked. This nuclear material is generally designated as nucleoid, or chromatin body or nuclear equivalent.

Ribosomes:

Ribosomes are 70 S type consisting of 50 S and 30 S sub-units. Some ribosomes are free in the cytoplasm and some are attached to inner surface of the cytoplasmic membrane.

Volutin granules (reserve source of phosphate), poly- β -hydroxybutyrate (PHB) and glycogen (both serving as source of carbon and energy) are some of the granules present in the cytoplasm of some bacteria. Gas vesicles are present in bacteria that grow in aquatic habitat.

Spores:

Spore is a metabolically dormant form, which under appropriate conditions can undergo germination and grow out to form a vegetative cell. Spores produced within the cell are called endospores and the spores produced external to cell are called exospores.

Endospores are thick walled, highly refractile bodies that are produced (one per cell) by *Bacillus*, *Clostridium*, *Sporosarcina* and few other genera. They are generally formed at the end of the active growth or during stationary phase. They are extremely resistant to desiccation, staining, disinfecting chemicals, radiation and heat.

Exospores are formed external to the vegetative cell by budding at one end of the cell in the methane oxidizing genus *Methylosinus*. They are desiccation and heat resistant.

Conidiospores and Sporangiospores:

The bacteria, actinomycetes form branching hyphae. From the tips of these hyphae spores develop singly or in chains. If the spores are contained in an enclosing sac (sporangium), they are termed SPORANGIOSPORES, if not they are called CONIDIOSPORES. These spores can survive long periods of drying but they do not have high heat resistance.

Cysts:

Cysts resemble endospores in some ways, but their structure and chemical composition are different. Cysts are thick walled, desiccation resistant, dormant forms that develop by differentiation of vegetative cells. *Azotobacter* and some other genera produce cysts.

BACTERIAL GROWTH

GROWTH

The bacteria take up nutrients from their environment, which are converted into new cell substances like RNA, DNA, proteins, enzymes and other macromolecules. Growth is the orderly increase in all of the components of an organism. Thus, the increase in size that results when cell takes up water or deposits lipid is not true growth. Cell multiplication is a consequence of growth; in unicellular organisms, multiplication leads to an increase in the number of individuals making up a population or a culture.

CELL DIVISION AND REPRODUCTION IN BACTERIA:

Multiplication of bacteria takes place by one of the following methods – Transverse binary fission, Budding, Fragmentation, Conidiospores or Sporangiospores.

Transverse binary fission is the most common and important in the growth cycle of bacterial population, which is an asexual reproductive process. Infrequently, in some species, binary fission may be preceded by mating or conjugation of cells.

Fragmentation: Some bacteria produce extensive filamentous growth, which is followed by the fragmentation of these filaments into small bacillary or coccoid cells, each of which give rise to new growth. Eg. *Nocardia* species.

Spore Production: Some genera of bacteria produce reproductive spores called conidiospores or sporangiospores at the tip of filamentous growth, each of these spores give rise to a new organism. Eg : *Streptomyces*

Budding: A few bacteria also reproduce by a process known as budding where in the parent cell remains intact while a new cell buds off which again grows into a new organism.

Eg: *Rhodospseudomonas*, *Hyphomicrobium*

GENERATION TIME

In unicellular microorganisms, growth usually, involves an increase in cell number. A single cell continually increases in size until it is approximately double of its original size; then cell division occurs, resulting in the formation of two cells. During this cell division cycle all the structural components of the cell will double. The formation of two cells from one parent cell is called a 'generation time'. The generation time is thus the time required for the cell number to double. Because of this the generation time is also called as 'doubling time'. It is to be noted that during a single generation, both the cell number and the cell mass are doubled. Generation time vary widely among microorganisms any where between minutes to days, 20 minutes in *E. coli* to 33 hours in *Treponema*.

The number of generations per hour is usually determined by plotting cell number against time on a semi logarithmic scale and reading off directly the time required for the number to double. Alternatively, the generation time can be calculated directly solving the equation for $n = \text{number of generations} = \frac{\log N - \log N(o)}{\log 2}$.

Generation time $g = t/n$.

If we start with a single bacterium the increase in population by geometric progression $1-2-2^2-2^3-2^4-2^n$, where n is total number of generations.

Total population 'N' is expressed by $N^1 = 1 \times 2^n$ at the end of given time period.

Total population at zero time is = $N(o)$

Total population at end time is = $N(f)$

Population in given culture at time 't' is $N(f) = N^0 \times 2^n$

(or) initial population $\times 2^n$.

$\log 10^{N(f)} = \log 10^{N(o)} + \log 10^{2(n)}$ (or) $\log 10^{N(f)} = \log 10^{N(o)} + n \log 10^2$ (or)

$n = \frac{\log 10^{N(f)} - \log 10^{N(o)}}{\log 10^2}$

$\log 10^2$

$n = \log 10^{N(f)} - \log 10^{N(o)} \div 0.3010 = 3.3 (\log 10^{N(o)} - \log 10^{N(o)})$

For example, if an inoculum of 10^4 cells grows exponentially to 1×10^7 cells in 8 hours time.

$$n = \log 10^7 - \log 10^4 \div 0.3010 = 7 - 4 \div 0.3 = 10 \text{ generations.}$$

If n generations are taken place in 5 hours time, the growth rate was $10 / 5 = 2.0$ generations / hour and the generation time was $t/n = 5 \times 60 \text{ min} / 10 = 30 \text{ min}$ or 0.5 hour.

$$1/g = 1/0.5 = 2 \text{ generations per hour.}$$

Growth of fungi is different from other unicellular organisms that divide either by binary fission or by budding. In filamentous fungi growth occurs only at the tips of filament and therefore is not exponential. Moreover, extensive branching occurs in fungi and new ends are generated at which growth occurs. Thus, fungi growth is difficult to describe in simple mathematical terms.

GROWTH RATE

Growth rate is the change in cell number or mass per unit time. It is expressed as 'R' which is the reciprocal of generation time 'g'. It can be defined as the slope of the line when log of cells versus time is plotted ($R = 1/g$). Microbes generally respond linearly to a limiting nutrient concentration in the medium, which forms the principle for microbiological assays.

GROWTH YIELD

Balanced growth is a condition where all biochemical constituents are being synthesized at the same relative rates. Growth yield is the mass of cells produced per unit of a limiting nutrient concentration. It is denoted by $Y = (X - X_0)/C$, where X_0 = mass of initial population immediately after inoculation, X = mass of final population after cells enter stationary phase, C = concentration of the limiting chemical constituent in the medium. This is the basis used in microbiological assays of various vitamins and amino acids by auxotrophic mutants of bacteria.

GROWTH CYCLE OF BACTERIA

When a liquid medium is inoculated with unicellular bacteria or yeasts or other budding organisms, the population undergoes a characteristic sequence of events during

the increase in cell number. When the number of cell /ml is determined periodically and plotted against time, a curve is formed showing four distinct phases of growth.

A- Lag phase / Acclimatization phase

B- Log phase / exponential phase / Logarithmic phase

C- Stationary phase

D- Death phase / Declined phase

Lag Phase

Immediately after transferring into a fresh medium growth does not take place but only after a period of time called the 'lag phase'. This period may be brief or extended. There is no significant increase in the number of cells. However, cell growth occurs as indicated by increase in cell mass. This stage represents a period of active growth without cell division and the cell contents prepare for the cell division by extensive macromolecular synthesis. The length of the lag phase depends on a variety of factors such as the age of the inoculum, the composition of the growth medium and the environmental factors such as temperature, pH and aeration etc. At the end of lag phase each organism divides. However, since not all organisms do not complete the lag period simultaneously, there is a gradual increase in the population until the end of this period when all cells are capable of dividing at regular intervals.

If an exponentially growing culture is inoculated into the same fresh medium under the same conditions of growth, a lag is not seen and exponential growth continues at the same rate. However, if the inoculum is taken from a old (stationary phase) culture and inoculated into the same medium a lag usually occurs even if all of the cells in the inoculum, are alive. This is because the cells are usually depleted of the various essential coenzymes or other cell constituents and time is required for synthesis. A lag occurs when the cells are damaged by treatment with heat, radiation or toxic chemicals due to the time required for the cells to repair the damage. A lag is observed when the cell population is transferred from a rich medium to a poorer one. This occurs since cells must have a complete complement of enzymes for the synthesis of the essential metabolites not present in that medium on transfer to a new medium, time is required for synthesis of new enzymes.

Log Phase

Most unicellular microorganisms grow exponentially but rates of exponential growth vary greatly. The rate of exponential growth is influenced by environmental conditions (temperature, aeration, composition of culture medium) as well as by characteristics of the organism itself. During exponential phase cells are in a steady state. New cell material is synthesized at a constant rate but the new material is itself catalytic and the mass increases in an exponential manner. This continues upto a point when one or more nutrients in the medium become exhausted or toxic metabolic products accumulate and inhibit growth. For aerobes, once cell population reaches 1×10^7 cells /ml, the growth rate will decrease unless O_2 is forced into the medium by agitation or bubbling in air. When the cell concentration reaches 5×10^9 / ml the rate of oxygen diffusion cannot meet the O_2 demand even in an aerated medium and growth is progressively slowed. The time taken for log phase is different for different microorganisms. Some bacteria take 20-30 minutes to grow, some soil bacteria take about 60-150minutes. Bacteria like *Nitrisomonas*, *Nitrobacter* normal few hours, *Mycobacterium tuberculosis* take about 12-24 hours to grow. Metabolites which are produced during log phase are known as Primary metabolites. Primary metabolites are producing only during this phase and are required for cell division and growth.

It is possible to maintain a bacterial culture continuously in exponential phase for a required period of time provided that the fresh medium is supplied and toxic products or metabolic wastes accumulated in the medium are removed. Such continuous culturing is possible by devices known as 'chemostat' and 'turbidostat'. The continuous culture methods have been extremely useful both for genetic and biochemical studies. This condition is obtained by growing the bacteria in continuous culture, a culture in which nutrients are supplied and end products are removed continuously. These cultures do not represent synchronous cultures since these do not contain cells that are physiologically identical. In chemostat fresh medium is added continuously at a given rate to a growing culture and excess volume thus generated is removed with an over flow mechanism. The level of growth is controlled by maintaining a fixed, limiting concentration of a particular nutrient in the medium. The concentration of media is steadily maintained so growth rate adjusts automatically to dilution rate.

In turbidostat, a photoelectric device continuously monitors the cell density or turbidity of the culture vessel and controls the dilution rate to keep the constant turbidity either by increasing or decreasing the exchange of medium accordingly.

In a photostat, which is used to get steady state cultures of photosynthetic organisms, growth rates can be controlled by controlling the light supply.

Stationary Phase

In a closed system, exponential growth cannot occur indefinitely. If a single bacterium with 20 minutes generation time continued to grow exponentially for 48 hours, it may produce a population that weighs about 4000 times the weight of the earth. In fact a single bacterial cell weighs about one trillionth of a gram. It does not happen in the nature since the growth is limited or ceased either due to the exhaustion of nutrients or due to the accumulation of toxic products. In most cases, however, cell turnover takes place in the stationary phase. There is a slow loss of cells through death, which is just balanced by the formation of new cell through the growth and division. When this occurs, the total cell count slowly increases although the viable count stays constant. Some spore forming bacteria, form endospores when they reach stationary phase if they are resistant to lysis or death. In such cases the number of viable cells will remain constant after attaining the stationary phase and a phase of decline or death may not be seen. Certain cell metabolites called secondary metabolites are produced primarily in the stationary phase. Secondary metabolites include toxins, antibiotics, sterols etc. These products inhibit the growth and survival of other microorganisms and may give competitive advantage to the producer of Secondary metabolites

Death Phase

If incubation continues after a population reaches the stationary phase, the cells may remain alive and continue to metabolize, but often they die. If the latter occurs, the population is said to be in the death phase. The total count may remain constant while the viable count slowly decreases. In some cases death is accompanied by cell lysis leading to decrease in total count. As there is no food materials available, accumulation of toxic material leads to death of microorganisms. The cells start dying exponentially and hence we can see a sharp declined in the growth curve. After a majority of cells are dead, a small

number of survivors may persist for months or even years which may be due to the growth of a few cells at the expense of nutrients released from cells that die and lyse.

The terms lag, exponential, stationary and death phases do not apply to the individual cells but only to populations of cells. Transitional periods between growth phases indicate that not all the cells are in exactly the identical physiological condition toward the end of any given phase of growth. Time is required for some cells to catch up with others. It is necessary to note that during some phases of growth the cells are young and actively metabolizing while during others they are dying, so that there may be enormous structural and physiological differences between cells harvested at different times. Physical conditions and chemical substances may also have profound effect on organisms in different phases of their growth. Generally, cells in the log phase of growth are the most uniform and in a more clearly defined condition than others and therefore used for physiological and metabolic studies.

SYNCHRONOUS GROWTH

It is very desirable to have an entire population of cells in the same stage of their growth cycle, for studying cell growth, organization and differentiation. It is not possible to analyze a single bacterial cell. Results from analysis of culture wherein all cells are in same stage of growth can be interpreted as that for a single cell.

Under ordinary conditions, in an exponentially growing culture, only a small percentage of cells are actively dividing during at any one point of time.

A growth pattern wherein every cell in a culture is in the same metabolic state and divides at one time is defined as synchronous growth. Therefore the increase in cell number is rather step wise than continuous. The synchrony generally lasts for only a few generations, may be 3-4 divisions, since even the daughters of single cell soon get out of phase with one another and cell division becomes random. In most bacterial cultures, especially, in log phase the bacteria are in various stages of cell division and hence, it becomes difficult to understand the properties of microorganisms. To overcome this problem, microbiologists developed cultures in which the bacteria grow synchronously.

When the bacteria grow synchronously, a synchronous population can be generated by maintaining the physical conditions or by changing the environment of the culture or by manipulating the chemical composition of the culture medium. Synchrony

can be achieved by inoculating the cells and maintaining the culture at sub optimal temperatures for some time so that these cells will metabolize slowly but do not divide. But when the temperature is raised to optimum, all the cells will undergo a synchronized division. Another method to have a synchronous culture is to separate the smallest cells in log phase culture by filtration or by differential centrifugation, which are reasonably well synchronized with each other as these cells were just divided before their separation by filtration.

DIAUXIC GROWTH

In a medium containing two carbon sources, bacteria such as *E. coli* display a growth curve, which is called 'diauxic'. This phenomenon was demonstrated by J. Monod. When *E. coli* is supplied with a medium containing glucose and lactose, glucose is utilized first and only after depletion of glucose in the medium, the second C source, lactose is utilized for its growth. This happens because of the fact that the glucose metabolizing enzymes are always present in the cells (constitutive enzymes) irrespective of whether glucose is present in the medium or not, but not lactose metabolizing enzymes which are synthesized in the cell only in presence of the substrate, lactose. The *E.coli* preferentially utilizes the glucose as the enzyme is already present in the cell and therefore does not synthesize the lactose metabolizing enzymes. Since there is no alternative for *E. coli* to utilize lactose, after the exhaustion of glucose in the medium, it utilizes lactose. The time lapse between exhaustion of glucose and utilization of lactose, required for the synthesis of enzymes, for lactose utilization, is the second lag period that is observed in diauxic growth curve.

Lecture - 7

HETEROTROPHY

The Heterotrophs depend on organic compounds for supply of both carbon & Energy. They oxidize organic compounds, the hydrogen & electrons released from these compounds (substrates) may be finally transferred to oxygen producing water or they may be transferred to other inorganic or organic acceptor causing their reduction. In the first case the organism carry out an aerobic respiration. In the second case, the organism carry out either respiration or fermentation & the type of metabolism is fermentative.

RESPIRATION:-

Respiration is a catabolic mechanism during which energy is conserved with the involvement of molecular O₂ (aerobic respiration) or some other externally derived electron acceptor (anaerobic respiration) respiration may be divided into 2 stages. In the first stage the monosaccharides (glucose & other sugars), amino acids, fatty acids, glycerol & other products of larger nutrient molecules (polysaccharides proteins & lipids) are degraded to a few simpler molecules (eg, Pyruvate, Acetyl, co & TCA cycle intermediates) employing several metabolic pathways such as glycolysis, HMP pathway, Enter – Duodroff pathway.

This first stage is common to both aerobic & anaerobic respiration & often produces some ATP as well as NADH or FADH₂. In the second stage the end products of the first stage are completely oxidized via TCA cycle producing ATP, NADH & FADH₂. Actually, the aerobic & anaerobic distinction becomes apparent during the second stage of respiration either the electrons derived during this stage are accepted by molecular O₂ (aerobic) or they are accepted by exogenous electron acceptors such as NO₃, SO₄⁻², CO₂, Fe³⁺, SeO₄²⁻ (anaerobic).

GLYCOLYSIS

Glycolysis is the sequence of reactions that metabolizes one molecule of glucose to 2 molecules of pyruvate with net production of 2 molecules of ATP. Glycolysis occur in all major groups of microorganisms & functions in the presence or absence of O₂. It is located in the cytoplasmic matrix of the cells of an organism.

1. Glucose is activated for subsequent reactions by its phosphorylation to yield glucose 6 phosphate with ATP as the phosphoryl donor. This reaction is catalyzed by hexokinase.
2. Enzyme phosphohexose isomerase catalyses the reversible isomerisation of glucose 6 phosphate to fructose 6 phosphate
3. Phosphofructokinase catalysis the transfer of a phosphoryl group from ATP to fructose 6 phosphate to yield fructose 1,6 biphosphate.
4. The enzyme fructose 1,6 biphosphate aldolase, catalyses the cleavage of fructose 1,6 biphosphate to yield 2 different triose sugar phosphates, glyceraldehyde 3 phosphate & dihydroxy acetone phosphate.
5. Glyceraldehyde 3 phosphate & dihydroxy acetone phosphate are inter convertible only glyceraldehyde 3 phosphate is directly degraded in subsequent steps & dihydroxy acetone phosphate is readily reversibly converted into glyceraldehyde 3-phosphate by the enzyme triose phosphate isomerase.
6. Glyceraldehyde 3 phosphate oxidizes to 1,3 biphosphoglycerate with involvement of glyceraldehyde – 3 phosphate dehydrogenase during this reaction NAD^+ is reduced yielding NADH. 1,3 biphosphoglycerate is converted to 3-phosphoglycerate.
7. In this reaction the enzyme phosphoglycerokinase transfers the high energy phosphoryl group from 1,3 biphosphoglycerate to ADP yielding ATP & 3-phosphoglycerate. The formation of ATP by phosphoryl group transfer from a substrate (1,3 biphosphoglycerate) is called substrate level phosphorylation.
8. 3- phosphoglycerate is converted to 2-phosphoglycerate. In this reaction the enzyme phosphoglycerate mutase catalyses a reversible shift of the phosphoryl group between c-2 & c-3 of glycerate.
9. In this step the enzyme enolase promotes reversible removal of a molecule of H_2O from 2-phosphoglycerate to yield phospho enol pyruvate
10. Phosphoryl group from phosphoenol pyruvate is transferred to ADP by enzyme pyruvate kinase to yield ATP & Pyruvate via Substrate level phosphorylation. The

enzyme pyruvate kinase requires K^+ for its activity. The whole of glycolysis can be represented by following equation

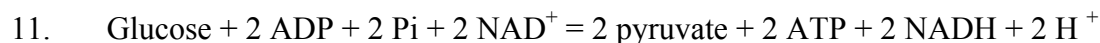

ENTNER-DOUDOROFF PATHWAY (ED PATHWAY)

ED pathway is another pathway utilized by bacteria to convert glucose to pyruvate. The bacteria that use this pathway are mostly gram-negative & rarely gram-positive. Two key enzymes of the ED pathway are 6-phosphogluconate dehydrogenase & 2-keto-3-deoxy gluconophosphate aldolase (KDPG – aldolase) this pathway occurs in bacteria of genera *Pseudomonas*, *Rhizobium*, *Azotobacter*, *Agrobacterium*, *Zymomonas*, but are absent in gram-positive bacteria except for a few *Nocardia* isolates & *Enterococcus faecalis*.

Glucose is phosphorylated to glucose 6-phosphate which is then oxidized to 6-phosphogluconate. 6-phosphogluconate is dehydrated to form 2-keto, 3-deoxy 6-phosphogluconate, the key intermediate compound in this pathway. 2-keto, 3-deoxy 6-phosphogluconate (KDPG) is then cleaved to pyruvate & glyceraldehyde-3-phosphate by the enzyme KDPG – aldolase. Glyceraldehyde-3-phosphate enters into the glycolytic pathway & is converted finally to pyruvate. This pathway yields 1 ATP, 1 NADH & 1 NADPH per glucose metabolized.

PENTOSE PHOSPHATE PATHWAY OR HEXOSE MONO PHOSPHATE PATHWAY

HMP pathway is the other common pathway to breakdown glucose to pyruvate & operates in both aerobic & anaerobic conditions. This pathway produces NADPH, which carries chemical energy in the form of reducing power, which is required in many biosynthetic reactions of the cell, & it provides pentose phosphates for use in nucleotide synthesis.

This pathway involves the initial phosphorylation of glucose to form glucose 6-phosphate, glucose 6-phosphate is oxidized to 6-phosphogluconic acid with the simultaneous production of NADPH and subsequent oxidation to with production of another molecule of Decarboxylation of 6-phosphogluconic acid together with a yield of

NADPH, produces ribulose 6 phosphate, epimerization reaction on Ribulose 6-phosphate yields xylulose 5 phosphate & ribose 5 phosphate. The 2 compounds are the start point for a series of transketolase reactions & transaldolase reaction leading subsequently to the initial compound of the pathway, glucose-6 phosphate thus completing the cycle. i.e. glucose 6- phosphate. The overall reaction is as follows.

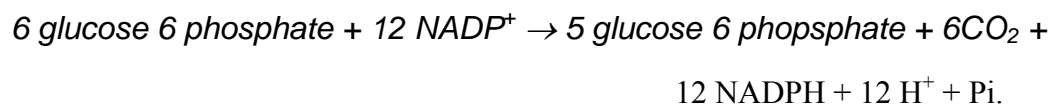

TRICARBOXYLIC ACID CYCLE (TCA cycle)

TCA cycle or citric acid is the central metabolic pathway of the cell & is the gateway to the aerobic metabolism of any molecule that can be transformed into an acetyl group or dicarboxylic acid.

Pyruvate is first decarboxylated & converted into acetyl - CoA, which is the connecting link between glycolysis & TCA cycle & acts as the fuel for TCA cycle. Acetyl - CoA is a 2 carbon energy rich molecule, which initiates TCA cycle & is condensed with a 4 - carbon intermediate, oxaloacetate, to form citrate & to begin the 6 carbon stage.

The citrate is isomerised to give Isocitrate, which is oxidized & decarboxylated twice to produce α - keto glutarate, then succinyl-co-A. During this, 2 NADH molecules are generated & 2 carbons are released from the cycle as CO₂. Succinyl Co-A is converted into oxaloacetate via formation of succinate, fumarate & L- malate. During two oxidation steps succinate, to fumarate & l-malate to oxaloacetate 1 FADH₂ & 1 NADH produced. GTP is produced during conversion of succinyl CoA to succinate. Finally, the oxaloacetate is reformed & becomes ready to join acetyl-CoA to proceed further.

Kreb's cycle generates 2 CO₂ molecules, 3 NADH, one FADH₂ & 1 GTP molecules. For each acetyl CoA molecule oxidized. The generation of ATP from NADH & FADH₂ molecules associated with electron transport chain & oxidative phosphorylation. The generation of GTP molecule takes place via substrate level phosphorylation.

Overall reaction of the TCA cycle is

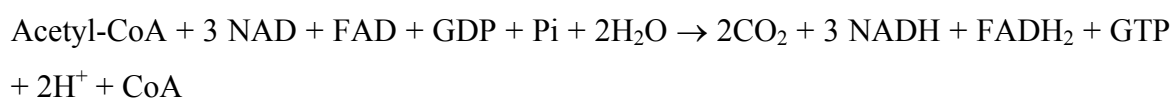

Electron transport chain (oxidative phosphorylation)

When one glucose molecule is oxidized to 6 CO₂ molecules by way of glycolysis & TCA cycle, only the equivalent of 4 ATP molecules is directly synthesized most of the ATP molecules are generated from the oxidation of NADH, the reduced form of nicotinamide dinucleotide (NAD⁺) in the electron transport chain

In eukaryotic microorganisms (including other eukaryotes) the electron transport chain operates in mitochondria whereas in prokaryotic microorganism (bacteria) it operates in plasma membrane.

Electron transport chain in Bacteria vary in their electron carriers (eg in their cytochromes) & are usually branched. Bacterial electron transport chains are usually shorter than mitochondrial transport chain.

Electron transport chain of *E.coli* transports electrons from NADH (NADH is the electron donor) to acceptor & move protons (H⁺) across the plasma membrane. *E.coli* transport chain is short, consists of 2 branches (cytochrome d branch & cytochrome O branch) & different cytochromes (eg, cyt b₅₅₈, cyt b₅₆₂, cyt d, cyt o). Coenzyme Q (ubiquinone) carries electrons & donates them to both branches but the branches operate under different growth conditions.

The cyt d branch shows very high affinity for O₂ & operates at low O₂ levels usually when the bacterium is in stationary phase of growth. This branch is not as efficient as the cytochrome branch because it does not actively pump protons to periplasmic space. The cyt o branch shows moderately high affinity for O₂ & operates at high O₂ concentration. This branch operates when bacterium is in log phase of its growth & actively pumps protons H⁺ in to periplasmic space.

GLYOXYLATE CYCLE:-

The glyoxylate cycle is used by some microorganisms when acetate is the sole carbon source or during oxidation of primary substrates that are converted to acetyl CoA without the intermediate formation of pyruvic acid. This pathway does not occur in higher organisms because they are never forced to feed on 2-carbons molecules alone.

The specific enzymes of the glyoxylate cycle are isocitrate lyase & malate synthase. The overall reaction of the glyoxylate cycle is:



Acetyl CoA enters the cycle at two places it condenses with oxaloacetate to give citrate which is the entry point for the TCA cycle and the further reaction leads to the formation of isocitrate lyase is a splitting enzyme that produces succinate & glyoxylate. The second acetyl CoA molecule condenses with glyoxylate to give malate by the action of malate synthase. Enzymes which carry out replenishment reactions such as this are known as Anaplerotic enzymes. Their function is to maintain the pool of essential intermediates for biosynthesis.

ANAEROBIC RESPIRATION

Anaerobic respiration is an alternate mode of energy generation in which an exogenous electron acceptor other than O_2 is used in electron transport chain leading to a proton motive force. The electron acceptors used in anaerobic respiration include nitrate (NO_3^-), sulphate (SO_4^{2-}), Carbonate (CO_2), Ferric ion(Fe^{+3}) & even certain organic compounds (eg. Fumarate Chloate, Trimethyl amine oxide etc.)

Types of anaerobic respiration

1. NITRATE (NO_3^-) RESPIRATION (Nitrate Reduction):-

Nitrate (NO_3^-) is one of the common type of inorganic electron acceptor used in anaerobic respiration & is reduced to NO_2^- , NO , N_2O & N_2 . The products of nitrate respiration are all gaseous, they can be easily released to atmosphere & because of this process is called denitrification.

The biochemical mechanism of nitrate (NO_3^-) respiration or dissimilative metabolism of nitrate has been well studied in microorganism like *E.Coli*, *Paracoccus denitrificans*, *Pseudomonas stutzeri*.

In *E.coli* the NO_3^- is reduced only to NO_2^- through electron transport chain in which NADH acts as electron donor & NO_3^- as electron acceptor electron.

In *Paracoccus denitrificans*, *Pseudomonas stutzeri* the NO_3^- is reduced to nitrogen oxides (NO_2^- , NO ,) by a series of enzymes including nitrite reductase, nitric oxide

reductase, nitrous oxide reductase. During electron transport in both cases, a proton motive force is established across the plasma membrane & ATP is synthesized by ATPase enzyme.

2. SULPHATE (SO₄²⁻) RESPIRATION:-

The end product of sulphate respiration is H₂S an important natural product that participates in many biogeochemical processes.

Various sulphate reducing bacteria such as *Desulfovibrio*, *Desulfomonas*, *Desulfatovaculum*, utilize lactate, pyruvate, ethanol or fatty acids as electron donors reducing sulphate to H₂S.

The sulphate (SO₄²⁻) is stable & requires activation before reduction. The activation of sulphate takes place by means of ATP; the enzyme ATP sulfurlyase.

Lecture -8

FERMENTATION

In the middle of the 19th century, Fermentation is said to be purely a microbiological process by Louis Pasteur. He studied various types of fermentations and demonstrated that each particular type of fermentation occur by the act of specific type of microorganism. The substances produced during fermentation are very useful natural products. Distillers, cheese makers, bakery exploit this property for the preparation of fermentation products on industrial scale. Fermentation can be defined as a reaction in which organic compounds serve both as electron donors & electron acceptors. It is also defined as an internally balanced ATP generating oxidation – reduction process in which an organic compound i.e., a substrate is partially oxidized or partially reduced. Since there is no net oxidation in a fermentation, the number of moles of C, H & O remain same in the products as in the substrate as it occurs in the conversion of glucose to lactic acid or ethanol.

Energetically fermentations are poor energy yielding processes. Fermentation differs from anaerobic respiration in that, in the later oxygen is replaced by an inorganic electron acceptor such as NO⁻³. The term fermentation is loosely used to denote any process which microorganisms are involved even if the process involved strong aeration

and is respiratory in nature as in antibiotic fermentations. Hence, fermentation is broadly defined as any large scale conversion carried out either by microorganisms or by their products like enzymes.

Microorganisms ferment various sugar compounds and the type of fermentations are basically ethanol, lactic acid, mixed acid, propionic acid, butyric acid, mixed amino acid and butanediol types.

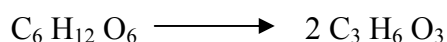

Or

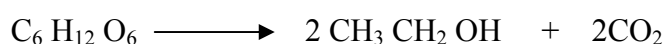

Glucose

ethanol

Carbon dioxide

In fermentation, the end product of glucose break down via EMP or EDP is pyruvic acid which is transformed into various compounds, depending on the organisms. Pyruvic acid acts as H acceptor & regenerates NAD while getting itself reduced to Lactic acid.

Successful production of organic chemicals using microorganisms is dependent on several factors such as the organism, the raw materials and the cultural conditions. A desired end product is obtained in large quantities by utilizing a suitable microbe and a cheap raw material. The improvement of these processes is possible either by manipulating the cultural conditions of fermentation or addition of a few chemicals in the medium or by genetic manipulation of organisms including mutations, hybridization etc.

Components of a fermentation includes Substrate / raw materials; Microorganisms; Bioreactor/ fermentor; End product

Sugar —*Saccharomyces cerevisiae*

Alcohol

Fermentation conditions includes pH, temp, time, aeration etc.

List of different types of fermentation:

1. ETHANOL FERMENTATION:-

In alcoholic fermentation, pyruvate which is first activated, is then converted by pyruvate decarboxylase into acetaldehyde & CO₂. Acetaldehyde is then reduced to ethanol in a NAD linked reaction involving alcohol dehydrogenase.

This fermentation is a major pathway in some yeasts *Saccharomyces cerevisiae* but is not important in bacteria.

2. LACTIC ACID FERMENTATION:-

In this fermentation, a NAD linked lactic dehydrogenase reduces pyruvate to lactate. Lactic acid bacteria such as *Lactobacillus casei*, *Streptococcus cremoris* etc. carry out lactic acid fermentation in which lactic acid is the only end product. Lactic acid bacteria consists of 2 sub groups based on the nature of the product they form. They are Homolactic fermentors and heterolactic fermentors.

In both, alcohol and lactic acid type of fermentation the net yield of ATP is 2 per mole of Hexose. Two moles of ATP are consumed in the formation of a hexose diphosphate from glucose & 4 moles of ATP are subsequently produced, the net yield is 2 moles of ATP per mole of hexose.

3. PROPIONIC ACID FERMENTATION:

In this fermentation, pyruvate is first carboxylated to yield oxaloacetate which is then reduced to succinate & then decarboxylated to propionate.

Pyruvic acid → Oxaloacetic acid → Succinic acid → Propionic acid

Propionibacterium is exclusively used in the preparation of Swiss cheese. This type of fermentation mostly occur in the rumen (stomach) of ruminants and grain eating animals.

4. MIXED ACID FERMENTATION

This fermentation is characteristic of most members of enterobacteriaceae which dispose a part of glucose through lactic acid fermentation & a part through another fermentation in which pyruvate is split without net oxidation or reduction to an acetyl

group & formic acid. The major end products are pyruvate, succinate and formic acids.

E.coli

5. ACETONE – BUTANOL TYPE:-

This kind of fermentation is carried out by strict anaerobes such as *Clostridium*. The glucose is initially cleaved to H₂, CO₂ and two carbon fragments. Two such fragments are condensed to yield acetoacetyl CoA that is de-carboxylated and or reduced to acetone, isopropanol, butyrate and n-butanol in varying proportions.

6. 2,3 BUTANE DIOL TYPE: -

This is carried out by *Enterobacter* sp. By the condensation of two lactate molecules, acetolactic acid is produced which is further converted to butane diol. The glycolytic pathway of glucose is the most common pathway in microorganisms and reflect a common evolutionary path and selection of most effective mechanisms in different microorganisms.

7. MIXED AMINO ACID TYPE: -

This type of fermentation occur during putrefactive processes in which certain amino acids serve as electron donors and while others serve as acceptors. A large number of *Clostridia* putrefy protein rich substrates and produce unpleasant odours.

CHEMOAUTOTROPHY

Chemoautotrophs can grow in a mineral medium, during carbon from CO_2 & energy from the oxidation of inorganic compounds. Some of these bacteria are capable of growing both Chemoorganotrophically & chemoautotrophically i.e., they are facultative autotrophs. Example of these types are *Alcaligenes eutrophus*. Other chemoautotrophic bacteria are obligate in nature Eg. *Thiobacillus*, *Nitrosomonas*.

Reaction which yield energy in chemoautotrophs are the oxidation of H_2 , NH_4^+ , NO_3^- , S & reduced sulphur compounds and Fe^{++} . All these oxidations, except H_2 oxidation, couple electron transport to the cytochrome system & NAD^+ reduction occurs by energy dependent reverse electron flow.

The assimilation of CO_2 in these organisms occur through the reaction of the calvin cycle. When grown chemoautotrophically, cells contain high levels of the 2 enzymes of this pathway namely carboxy dismutase, phosphoribulokinase.

Depending on the oxidisable inorganic substrate, the chemoautotrophic bacteria can be distinguished into following groups. Nitrifying bacteria, sulfur oxidizing bacteria, H_2 oxidizing bacteria, Iron oxidizing bacteria & carbon monoxide bacteria.

Nitrifying bacteria:

Nitrification is a natural process carried out by the nitrifying bacteria occurring in soil & aquatic bodies. It involves oxidation of ammonia liberated by decomposition of nitrogenous organic matter like proteins, nucleic acids, urea etc. The oxidation takes place in 2 steps – ammonia to nitrous acid & nitrous acid to nitric acid. The acids react with metal ions to produce the corresponding salts, nitrite & nitrate. Nitrate acts as main N-source of plants.

The 2 step nitrification carried out by two different groups of bacteria.

- I. First step involving oxidation of NH_3 to nitrous acid is called nitrosification. Eg. *Nitrosomonas*. The members of this genus are highly aerobic & strictly autotrophic.

The energy-yielding oxidation reaction of these bacteria can be represented as



- II. The second step of nitrification involves oxidation of nitrous acid to nitric acid & organisms are known as nitrifying bacteria., Eg. *Nitrococcus*

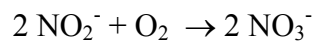

The organisms of both groups are capable of generating ATP by oxidative phosphorylation in course of electron transport through the cytochrome system of the respiratory chain & final electron acceptor is O_2 .

ATP generated in this way is utilized for CO_2 fixation by Calvin Benson cycle. The part of the ATP generated by oxidative phosphorylation is spent for driving electrons from nitrite to NAD through a reverse electron transport.

SULFUR OXIDIZING BACTERIA:-

Oxidation of elemental sulfur (S^0) & various reduced sulfur compounds, like sulfide (S^{2-}), thio sulfate ($\text{S}_2\text{O}_3^{2-}$) etc. takes place in soil & aquatic bodies mediated by both Eubacteria & Archae bacteria.

The best known among sulfur oxidizing eubacteria are members of genus *Thiobacillus*. Some species like *T. thiooxidans*, *T. thioparus* & *T. denitrificans* are obligately chemoautotrophic while *T. novellus* or *T. intermedius* are facultative.

Some eubacteria, designated as filamentous sulfur oxidizing bacteria belonging to the genera *Beggiatoa*, *Thiothrix* are able to oxidise sulfide (H_2S) to elemental sulfur (S^0)

The anoxygenic sulfur purple & green bacteria like *Chromatium*, *Chlorobium* etc. are able to oxidize sulfide to sulfur.

Thiobacilli oxidise elemental sulfur or sulfur compounds to sulfuric acid. The reactions are represented as

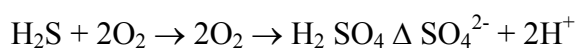

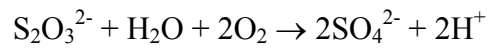

Other chemoautotrophic bacteria include

Iron - oxidizing bacteria - *Ferrobacillus ferro oxidans*, Hydrogen oxidizing bacteria - Hydrogen oxidizing bacteria are *Alcaligenes eutrophus*, All are facultative chemoautotrophs. A number of extremophilic archaeobacteria can grow as hydrogen bacteria eg. *Pyrodictium* (Anaerobic, obligately chemo autotrophic).

IMPORTANCE OF CHEMOAUTOTROPHS:

Chemoautotrophs play an important role in oxidation of reduced N and S compounds like NH_3 and H_2S to NO_3 and SO_4 respectively. Nitrates sulphates are the utilized forms of nutrients for higher plants.

PHOTOTROPHY

Phototrophy refers to an autotrophic mode of metabolism in which organisms are able to utilize light energy with the help of photosynthetic pigments and convert it to chemical bond energy in the form of ATP (photophosphorylation). Phototrophic organisms are able to form organic compounds from carbon dioxide, generally through Calvin - Benson cycle. The 2 processes i.e generation of ATP by photophosphorylation & CO₂ fixation together constitute photosynthesis.

Cyanobacteria (blue green algae) carry out photo synthesis with O₂ as by product. Therefore the type of photosynthesis is known as oxygenic. There are some bacteria which contain bacterio-chlorophyll & carry out photosynthesis, but with out O₂ evolution (Anoxygenic)

Photosynthesis include two processes.

1. The first process include the reactions by which light energy is absorbed by the photosynthetic pigments & transformed into chemical bond energy. These reactions are photochemical in nature & are known as light reactions.
2. The second process include enzyme – catalyzed biochemical reactions involving CO₂ fixation in which light has no direct role. These reaction are called dark reactions.
3. The products of light reactions are ATP & NADH₂ or NADPH₂. These products are used in the dark reaction for synthesis of sugar or other organic compounds from CO₂.

PHOTOSYNTHETIC LIGHT REACTIONS:-

The first step in photosynthesis is the absorption of photons by a series of light harvesting pigments in pigment – protein complexes. These are called antenna – complexes. The light absorbed by the antenna system is transmitted to a reaction center. The reaction center being excited ejects energy rich electrons which are accepted by the primary electron acceptor ferredoxin. Electrons from ferredoxin are then transferred to the secondary electron acceptor as a result the reaction center remains positively charged (due to loss of electrons)

Appropriate position of secondary electrons acceptor leads to an electron transport in one direction across the membrane & proton transport in an opposite direction with the consequent generation of an electric field.

The overall electron flow resulting in ATP generation in photosynthesis can be of 2 main types cyclic & Non cyclic.

CYCLIC PHOTO PHOSPHORYLATION IN BACTERIA:-

In the cyclic type, the high energy electrons ejected by the reaction center pigment flow through a series of electron acceptors from a higher energy level to a gradually lower energy level & return to the reaction center, forming there by a close circuit. The lose of energy of electrons in this cyclic path is utilized for phosphorylation of ADP to ATP. The only product of cyclic path is ATP. No NADH_2 is produced.

PHOTOPHOSPHORYLATION

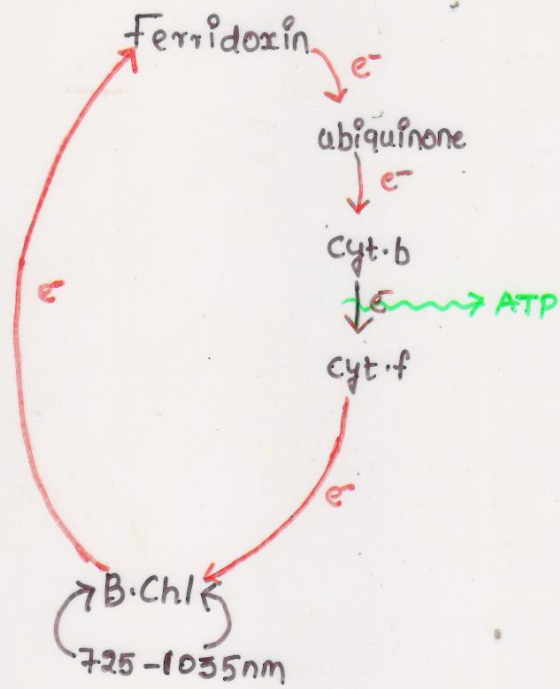

CYCLIC PHOTOPHOSPHORYLATION IN
ANOXYGENIC BACTERIA

CYCLIC AND NON CYCLIC PHOTO PHOSPHORYLATION IN CYANOBACTERIA:-

In non-cyclic photo phosphorylation electrons ejected by the reaction center pigment complex & accepted by ferredoxin are used for reduction of NAD/NADP

In case of green plants & cyanobacteria, H₂O acts as the electron donor. Water is photolysed by chlorophyll to yield H⁺ & OH⁻. Protons are used for reduction of NADP, while electrons of OH⁻ are passed on to the positively charged reaction center through cytochromes & molecular O₂ is evolved. In green plant photo synthesis, two light reaction occur, photo system I (PS I) & photo system II(PS II). The pigment complexes of these 2 systems are P700 & P680 respectively.

In anoxygenic bacterial photosynthesis, the situation is some what different. Firstly, there is only one photo system which is PS I. PSII is absent in bacterial non cyclic electron transport. The exogenous electron donor may be H₂, H₂S, S⁰, S₂O₃²⁻ or even organic compounds. In Anoxygenic photosynthetic bacteria, ATP is generated by cyclic photophosphorylation. The mode of production of the reducing force which is NADH₂ is variable in different groups & depends on the exogenous reductant used by the organism. NADH₂ production in photosynthetic bacteria may take place in different ways.

Firstly, when H₂ acts as an exogenous electron donor, NAD can be directly reduced to NADH₂

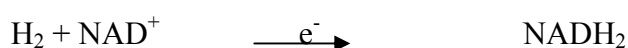

Another way may be reverse electron flow as it occurs in the nitrifying bacteria. The reverse election flow requires input of ATP. It may occur when H₂S, S⁰, or organic compounds are used as exogenous reductants by purple sulfur & purple non- sulfur bacteria.

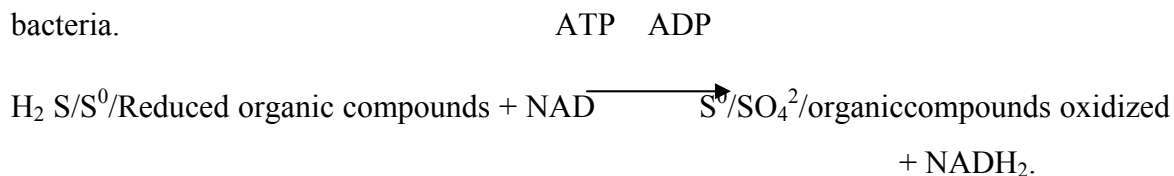

Third way of NADH₂ production appears to occur in green sulfur bacteria. These bacteria are able to utilize the light energy to transfer electrons from donor like H₂S, S₂O₃²⁻ etc. to NAD.

CYCLIC AND NON CYCLIC PHOTOPHOSPHORYLATION
HILL AND BENDALL Z-DIAGRAM.

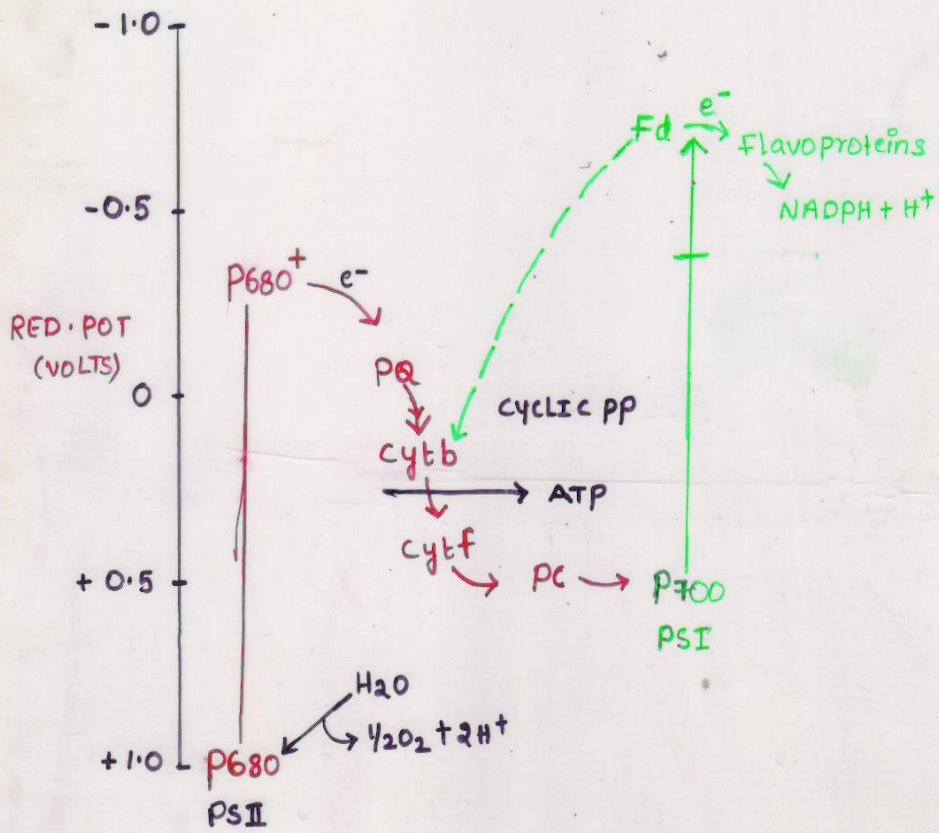

BACTERIOPHAGES

Viruses are non cellular infectious agents and they can be only seen with the aid of electron microscope. Size ranges from 20 to 300 nm. They are 10 – 100 times smaller than most bacteria and they can pass through the pores of filters which do not permit the passage of most bacteria.

They are obligate intracellular parasites. They can grow only in animal or plant cells or in microorganisms. They reproduce in these cells by replication. Viruses lack metabolic machinery of their own to generate energy or to synthesize proteins. They depend on host cells to carry out these vital functions. However, they have genetic information for replication and viruses also have information in their genes to use host cells energy generating and protein synthesizing systems.

Viruses are small packets of genes. The viral genetic material is either DNA or RNA but the virus does not have the both. (Host cells have the both). The nucleic acid (polynucleotide) is enclosed in a highly specialized protein coat of varying design. The coat protects the genetic material when the virus is outside of any host cell and serves as a vehicle for entry into another specific host cell. The structurally complete mature and infectious virus is called the virion.

Viruses may cause several diseases (plant, animal and human diseases). They are insensitive to broad range of available antibiotics as they are acellular.

D. Iwanowski (1892) discovered that the tobacco mosaic disease was filterable. **M.Beijerinck** (1898) confirmed this work. **W.Stanley** (1935) has crystallized the TMV. Animal viruses were also discovered during the same period. The vaccines were developed against viral diseases such as polio, measles and mumps.

Bacteriophages are the viruses that infect bacteria. They were independently discovered by **FW Twort** (1915, England) and **Fd' Herelle** (1917 – Pasteur institute). (Bacteriophage means bacteria eater). Bacteriophage is a tool for viral research and genetic research.

GENERAL CHARACTERISTICS OF BACTERIOPHAGES

- They are widely distributed in nature.
- Phages exist for most bacteria
- Like all viruses these are composed of nucleic acid core surrounded by a protein coat.
- They occur in different shapes.

There are two types of phages a) Lytic (virulent) and b) Temperate (avirulent) phages.

LYTIC(Virulent) PHAGES:

when lytic phages infect the bacteria, the bacteria respond by producing large number of viruses. At the end of the incubation period the host cell bursts or lyses, releasing new phages to infect other host cells. This is called a lytic cycle. Eg. T2 phage

TEMPERATE PHAGES:

In the temperate type of infection, the results is not so readily apparent. The viral nucleic acid gets integrated with bacterial DNA and replicated in the host bacterial cells from one generation to another without any cell lysis. However, temperate phages may spontaneously become virulent at some subsequent generation and lyse the host cells. Eg. Lambda (λ) phage

There are some filamentous phages which simply leakout of cells without killing them.

STRUCTURE AND MORPHOLOGICAL TYPES OF BACTERIOPHAGES

All phages have a nucleic acid core covered by a protein coat or capsid. The capsid is made up of morphological subunits, called capsomeres. Capsomeres are made of proteins known as protomers. The common morphological form of a phage consists of hexagonal head and a tail. The tail consists of contractile sheath, base plate and tail fibre.

TYPICAL BACTERIO PHAGE

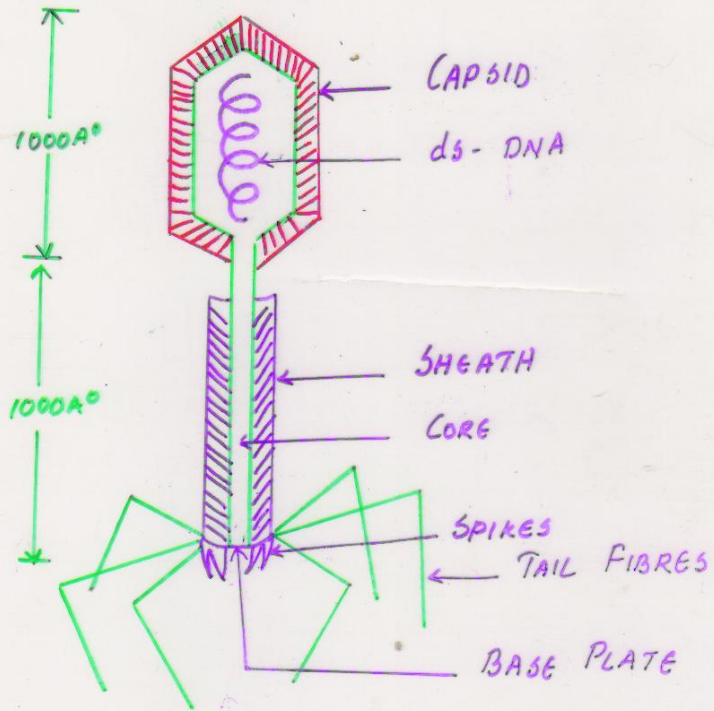

DIFFERENT MORPHOLOGICAL TYPES OF BACTERIA.

TYPE	A	B	C	D	E	F	G.
Morphology							
Nucleic acid type & No. of strands	DNA, 2	DNA, 2	DNA, 2	DNA, 1	RNA, 1	DNA, 1	RNA, 2
Examples of phages	Coliphages T2, T4, T6	Coliphages T1, T5	Coliphages T3, T7	Coliphages ϕ x174, S13	Coliphages F2, MS2	Coliphages Fd, F1	MV-L2

DIFFERENT MORPHOLOGICAL TYPES OF PHAGES

Bacterial viruses may be grouped into six morphological types.

- A. The most complex type has a hexagonal head, a rigid tail with a contractile sheath, and tail fibers.
- B. Similar to A this type has hexagonal head. However, it lacks a contractile sheath, its tail is flexible and it may or may not have tail fibers.
- C. This type is characterized by a hexagonal head and a tail shorter than the head. The tail has no contractile sheath and may or may not have tail fibers.
- D. This type has a head made up of large capsomeres but has no tail.
- E. This type has a head made up of small capsomeres but has no tail.
- F. This type is filamentous.
- G. This type is spherical.

Types A, B and C are morphologically unique to bacteriophages. The morphological types in group D and E are found in plant and animal (including insects) viruses as well. The filamentous form of group F is found in some plant viruses.

Phages A, B and C contain the double stranded DNA whereas phages D and F have single stranded DNA. Phage E has single stranded RNA, Phage G has double stranded RNA.

Like bacteriophages, animal and plant viruses are composed of central core of nucleic acid surrounded by a capsid, which is made up of capsomeres. They exhibit a characteristic symmetry.

- A. Icosahedral (20 triangular facets and 12 vertices) in the case of spherical viruses (polio viruses)
 - B. Helical in the case of rod shaped viruses (mumps , measles, influenza, rabies).
 - C. Complex in the case of miscellaneous group (pox viruses- small pox viruses)
- Like bacteriophages they may contain either DNA or RNA but not both in the same virion.

LYTIC AND LYSOGENIC CYCLES

There are two types of phages a) Lytic (virulent) and b) Temperate (avirulent) phages.

LYTIC PHAGES: when lytic phages infect the bacteria, the bacteria respond by producing large number of viruses. At the end of the incubation period the host cell bursts or lyses, releasing new phages to infect other host cells. This is called a lytic cycle.

TEMPERATE PHAGES: In the temperate type of infection, the results is not so readily apparent. The viral nucleic acid gets integrated with bacterial DNA and replicated in the host bacterial cells from one generation to another without any cell lysis. However, temperate phages may spontaneously become virulent at some subsequent generation and lyse the host cells.

Release of virions from the host cell may be by lysis or by a process that is essentially the reverse of phagocytosis.

REPLICATION OF BACTERIAL VIRUSES

1. The phage will attach to the bacteria by tail fibers.
2. The sheath contracts driving the tail core into the cell wall and membrane.
3. The virus injects its DNA, the way a syringe injects a vaccine.
4. Then the phage replicates inside the cell by utilizing the host cells biosynthetic machinery about 25 minutes after initial infection, some 200 bacteriophages will be produced and they come out by breaking bacterial cell.

LYTIC CYCLE:-

The lytic cycle of these bacteriophages can be divided into several stages like adsorption, penetration, synthesis of viral components, assembly of progeny virions & release from the infected cell.

i) Adsorption:-

The first step in infection of a host bacterial cell by a phage is adsorption. The tip of the virus tail becomes attached to the cell via specific receptor sites on the cell surface.

Attachment is specific in that certain viruses & susceptible bacteria have complementary molecular configurations at their opposing receptor sites.

Some bacterial mutants have lost the ability to synthesize specific receptors, they also become resistant to infection by the specific phage.

ii) Penetration:-

The penetration of phage into the host cell is mechanical. It may be facilitated by localized digestions of certain cell surface structures whether by phage enzymes (Lysozyme) carried on the tail of the phage or by the viral activation of host degradation enzymes.

In the T-even phages, penetration is achieved when.

- i) The tail fibers of the virus attach to the cell & hold the tail firmly against the cell wall.
- ii) The sheath contracts, driving the tail core into the cell through the cell wall & membrane
- iii) The virus injects its DNA the way a syringe injects the contents.

Transcription and Replication:-

Bacterial mRNA & bacterial proteins stop being synthesized within a few minutes after entry of phage DNA. Bacterial DNA is quickly degraded to small fragments & the nucleoid region of the bacterium becomes dispersed. Some phage mRNA is made immediately after infection. The amount of phage DNA increases after a brief delay. Specific proteins appear some what later, followed by appearance of organized capsid precursors & resulting in the formation of mature infectious capsids.

Immediate early phage genes are transcribed using the existing bacterial RNA polymerase. These genes code for nucleases that break down host DNA. Delayed early genes code for phage enzymes which produce unique phage DNA constituents such as 5-hydroxy methyl cytosine which replace cytosine in bacterial DNA. Delayed genes also code for polymerases & ligases that play specific role in phage DNA replication & recombination. Late gene products include structural components of new phage particles, lysozyme which lyse the bacterial cell, releasing the mature virions.

Assembly & release:-

After the synthesis of both structural proteins & nucleic acid, phage components begin to assemble into mature phages.

About 25min after initial infection, some 200 new bacteriophages are assembled & the bacterial cell bursts, releasing the new phages to infect other bacteria.

LYSOGENIC CYCLE

In lysogeny the viral DNA of the temperate phage instead of taking over the functions of the host cell genes, it is incorporated into the host DNA & becomes a prophage in the bacterial chromosomes acting as a gene. In this the bacterial cell metabolises & reproduces normally and the viral DNA is transmitted to each daughter cell in successive generations. Some times, the viral DNA is removed from the host's chromosome & the lytic cycle occurs. This process is called spontaneous induction. A change from lysogeny to lysis is induced by irradiation with ultraviolet light or by exposure to some chemicals.

VIROIDS:

Viroids are the nucleic acid entities of relatively low molecular weight and unique structure that cause several diseases of cultivated plants. Ex. Potato spindle tuber, citrus exocortis, chrysanthemum stunt, and cucumber pale fruit. Viroids are the smallest known agents of infectious disease. They do not contain a protein coat and exist only as short, infectious molecules of RNA. They replicate in cells of susceptible plant species. RNA is single stranded may be linear or circular.

PRIONS:-

Stanley prusiner was awarded noble prize for his work on prions. Prions are infectious proteinaceous molecules with a mol. wt. of 20,000 to 30,000 daltons. They cause diseases like Scrapie in sheep, mad cow disease, Cruetz Felt Jacob in humans etc. They effect nervous tissue & cause degeneration.

BACTERIAL GENETICS

Genetics is the study of the inheritance (heredity) and the variability of the characteristics of an organism. Inheritance concerns the exact transmission of genetic information from parents to their progeny. Variability of the inherited characteristics can be accounted for by a change either in the genetic makeup of a cell or in environmental conditions. Bacteria also show variations in characters like other higher organisms.

Variation: Bacteria are also capable of transmitting genetic information from generation to generation with great accuracy. However, in addition to the inheritance, which accounts for the constancy exhibited by biological species, there is variability or change expressed in the progeny. Variability may be due to adaptation or mutation.

Phenotype:

The observable characteristics of an organism

Genotype:

The precise genetic constitution / makeup of an organism

Genome:

The complete set of genes present in an organism

Plasmid:

In addition to the normal DNA chromosome, extra chromosomal genetic elements are often found in bacteria. The extra chromosomal genetic element that has no extra cellular form and exist inside cells simply as nucleic acid (double stranded circular DNA) that replicate independently of the host chromosome. Plasmids are the extra chromosomal genetic elements, capable of autonomous replication in the cytoplasm of bacteria. A plasmid which is able to integrate into the bacterial DNA is called Episome. Ex. F factor.

Some differences between prokaryotes and eukaryotes in genetic characters:

<u>S.No.</u>	<u>Genetic character</u>	<u>Procaryote</u>	<u>Eucaryote</u>
1.	Number of Chromosomes	1	> 1
2.	Chromosome composition →	DNA	DNA+Protein
3.	Genetic recombination →	Transformation / Transduction / Conjugation processes.	Sexual / Para sexual Process
4.	Cytoplasmic DNA →	Plasmids (Not membrane bound).	Mitochondria and Chloroplasts

Adaptation:

Change in an organism or population of organisms through which they become more suited to the prevailing environment. It can be genetic and or physiological. The phenotypic changes of bacteria due to environmental effect is known as adaptation. Bacteria like the cells of higher organisms, carry more genetic information (their genotype) than is utilized or expressed at any one time. The extent to which this information is expressed depends on the environment. For example, facultative anaerobic bacterium will produce different end products of metabolism, depending on the presence or absence of oxygen during growth.

A return to the original phenotype occurs when the original environmental conditions are restored. The phenotypic changes due to environment are different from phenotypic changes as a consequence of genetic changes due to mutation.

MUTATION:

Mutation is an heritable change in the base sequence of the nucleic acid genome of an organism.

A mutation is a change in the nucleotide sequence of a gene. The mutation leads to either no synthesis or synthesis of non-functional peptides. A cell or an organism which shows the effects of a mutation is called a mutant. In nature, mutations are rare events, which occur at random and arise spontaneously with no regard to environmental conditions. The rate of spontaneous mutation is very small and range from 1 in 1 million to 1 in 10 billion bacterial cells (10^{-6} to 10^{-10}). Generally, the mutants are masked by the un-mutated cells and it is difficult to locate the mutant. However, techniques were developed by microbiologists to isolate the mutants.

Contributions:

The discovery of deoxy ribonucleic acid (DNA) as the chemical basis of heredity in cells by **Oswald Avery, Colin Munro MacLeod and Maclyn Mc Carty** in 1944 led to the development of Genetics. One gene – one enzyme hypothesis was proposed by **Beadle and Tatum**. Fine structure analysis of gene was studied by **Benzer** using rII locus in T4 phage.

Salvador Luria and **Max Delbruck** in 1943 proved that mutations occur spontaneously in bacteria. More direct proof of preexisting mutants was provided by **Joshua Lederberg** and **Esther Lederberg** in 1952, with the help of Replica plating technique.

FLUCTUATION TEST OF LURIA AND DELBRUCK

FLUCTUATION TEST

The fluctuation test was performed by Luria and Delbruck to establish that the mutations occur in bacteria.

- A series of tubes containing 0.5ml of cells was incubated without phage until a certain population size was reached.
- The cultures were then exposed to phage by pouring the contents of each tube into an agar plate containing phage
- The number of phage – resistant mutants in each tube was thus determined.
- The colony counts from such a series of similar cultures were then compared with the results of a series of samples taken from one culture started with a similar density of cells per milliliter & allowed to reach a similar population number per millilitre
- The results showed that resistant bacteria arise spontaneously prior to the exposure to phage since a series of similar cultures yields results different from those obtained with a series of samples from one culture.

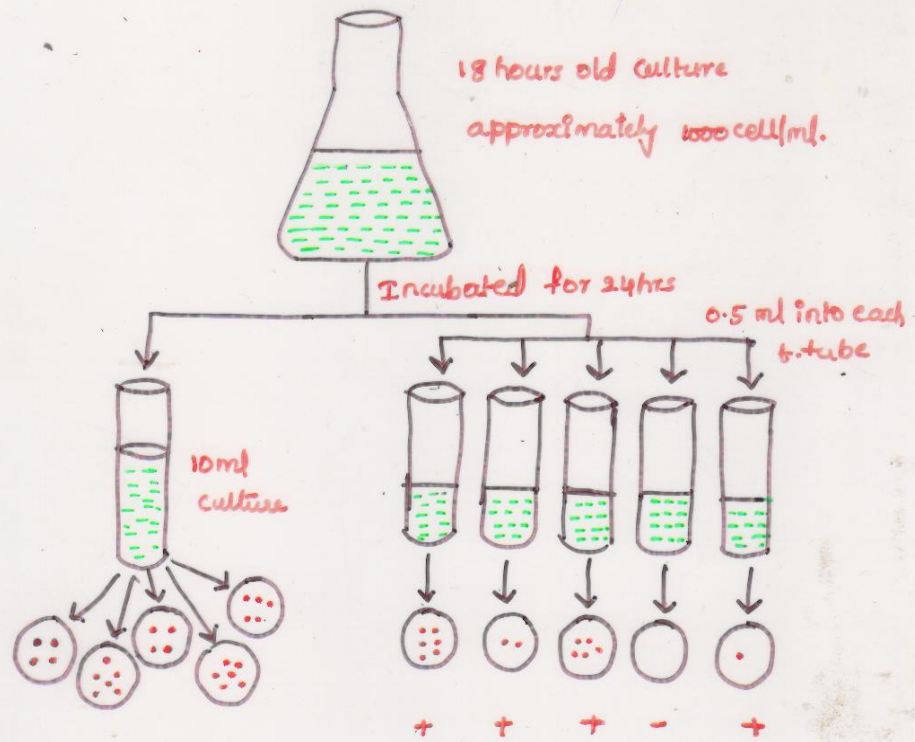

FLUCTUATION TEST

REPLICA PLATING

The Replica plating technique was developed by Joshua Lederberg & Esther Lederberg in 1952 for direct selection of bacterial mutants .

In this technique, the cells are first plated onto the complete medium to obtain well isolated colonies; on the master plate. A block of wood or cork of a size suitable for the master plate is covered with velvet cloth. This block is sterilized & then lowered into the master plate till the velvet touches all the colonies. Now the block is withdrawn & gently lowered onto a plate containing the selection medium so that the bacterial cells sticking onto the velvet are transferred onto the medium and such a plate is known as replica plate.

For detection of nutritional mutants, the selection medium is the minimal medium in which only wild type cells can grow. A reference point is marked both on the master plate & on the replica plate. This makes it possible to locate in the master plate any colony of the replica plate.

The colonies that develop on the selection medium plate are due to wild type cells. In contrast, those colonies of master plate that fail to grow on the minimal medium are nutritional mutants. The mutant colonies can be isolated from the master plate & used for further investigation like confirmation of their mutants, identification of the deficient biochemical etc.

Replica plating

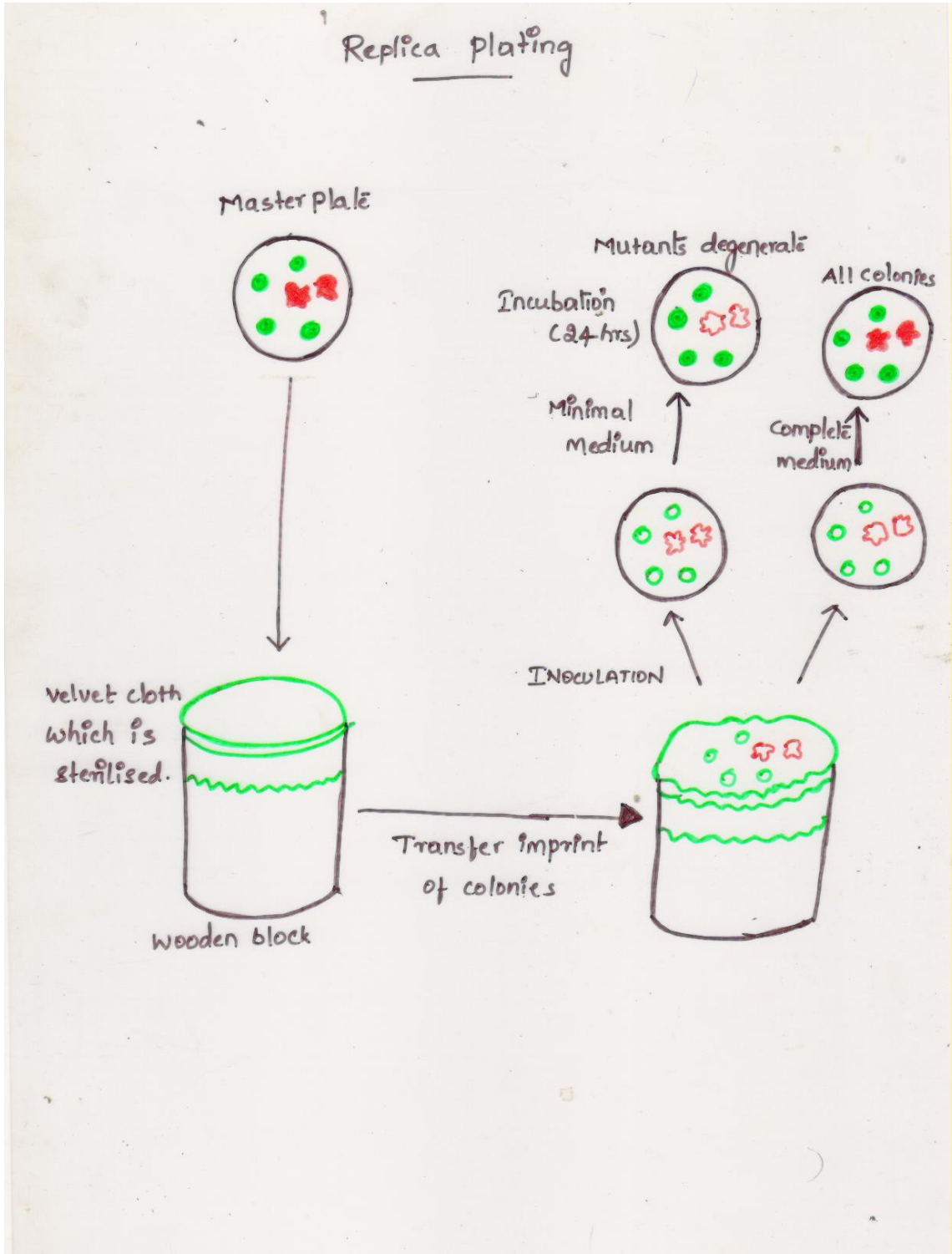

Lecture – 15

TYPES OF MUTATIONS

Two common types of mutations are A) Point mutations and B) Frame shift mutations.

A) Point mutations:

They occur as a result of the substitution of one nucleotide for another in the specific nucleotide sequence of a gene. The substitution of one purine for another purine or one pyrimidine for another pyrimidine is termed as '*transition*' type of point mutation. Replacement of a purine by a pyrimidine or vice versa is known as '*transversion*' type. This base-pair substitution may result in one of three kinds of mutations affecting the translational process.

- 1) ***Missense mutation***: In this type of mutation the altered gene triplet produces a codon in the mRNA which specifies an amino acid different from the one present in the normal protein. Such a protein may be functionally inactive or less active than the normal one.
- 2) ***Nonsense mutation***: The altered gene triplet produces a chain of terminating codon in mRNA resulting in premature termination of protein formation during translation. The result is incomplete polypeptide, which is non-functional.
- 3) ***Neutral mutation***: The altered gene triplet produces a mRNA codon which specifies the same amino acid because the codon resembling from mutation is a synonym for the original codon.

B). Frame shift mutations:

These mutations result from an addition or loss of one or more nucleotides in a gene and are termed *insertion* or *deletion* mutations respectively. This results in a shift of the reading frame of the genetic code and leads to the synthesis of non-functional proteins.

OCCURRENCE OF MUTATIONS

They commonly occur during DNA replication. Some mutations occur as a result of exposure to ultraviolet light or X –rays. Any agent that increases the mutation rate is called a mutagen. Mutations obtained by use of a mutagen are said to be induced, rather than spontaneous, though they differ only in frequency.

There are three main types of chemical mutagens.

- Compound that can react chemically with DNA. Ex: Nitrous acid which removes amino groups from purines and pyrimidines.
- Base analogs: 2-aminopurine is an analog of adenine. Base analogs cannot function as bases hence mutation.
- Intercalating agents: These are flat molecules that can intercalate (slip in) between base pairs in the central stack of DNA helix. By this means they distort the structures and cause subsequent replication errors. Ex. Acridine orange, nitrogen mustards.

Recently, it was shown that mutations can occur because of transposons. Transposons are the units of DNA which move from one DNA molecule to another inserting themselves nearly at random.

Mutations can be repaired with the help of endonucleases, exonucleases, polymerases and ligases.

Spontaneous Mutations:

Mutation which occur under natural conditions are called spontaneous mutations. Spontaneous mutation occur due to

1. Errors during DNA replication
2. Mutagenic effects of the natural environments of organisms
3. Transposons & Insertion sequences
4. Methylation, followed by spontaneous deamination of DNA bases especially cytosine.

Induced mutation:

Mutations produced due to the treatment with either a chemical or a physical agent are called induced mutations. The agents capable of inducing mutations are known as mutagens. Induced mutations are useful in two different ways

1. In genetics and biochemical studies
2. In genetic improvement of bacteria

The process of inducing mutations through treatment with a mutagen is known as mutagenesis.

The different mutagenic agents may be classified into two broad groups

1. Physical mutagens;
2. Chemical mutagens.

Physical mutagens:

The different types of radiations having mutagenic properties are known as physical mutagens. These radiation are high energy radiations and are grouped into two classes

1. Ionizing: Eg: X-rays, gamma rays
2. Non-ionizing radiations: Eg. UV rays.

Chemical mutagens:

The chemicals cause mutations are called chemical mutagens. Chemical mutagens can be divided into five main classes.

1. Base analogues: Eg. 5-bromouracil.
2. Alkylating agents: Eg. $-\text{CH}_3$ (methyl), $-\text{CH}_2\text{-CH}_3$ (ethyl) groups
3. Acridine dyes: Eg. Acriflavin, Proflavin
4. Deamination agents: Eg. Nitrous acid
5. Other mutagenic chemicals: Ethidium bromide

Lecture – 16

GENETIC RECOMBINATION

Genetic recombination is the formation of a new genotype by reassortment of genes following an exchange of genetic material between two different chromosomes which have similar genes at corresponding sites. These are called homologous

chromosomes and are from different individuals. Progeny from recombination have combinations of genes different from those that are present in the parents. In bacteria, genetic recombination results from 3 types of gene transfer.

- **Transformation:** Transfer of cell-free or 'Naked' DNA from one cell to another.
- **Conjugation:** Transfer of genes between cells that are in physical contact with one another, by means of conjugation tube.
- **Transduction:** Transfer of genes from one cell to another by a bacteriophage.

In bacterial recombination the cells do not fuse and usually only a portion of the chromosome from the donor cell (male) is transferred to the recipient cell (female).

BACTERIAL TRANSFORMATION IN PNEUMOCOCCUS

It was discovered by Griffith in 1928. During his work on mice with *Streptococcus pneumoniae*. Transformation is the process where the cell free or naked DNA containing a limited amount of genetic information is transferred from one bacterial cell to another.

The DNA is obtained from the donor cell by natural cell lysis or by chemical extraction. Once the DNA is taken up by the recipient cells, recombination occurs. Bacteria that have inherited specific characters from the donor cells are said to be transformed. Thus, certain bacteria, when grown in the presence of dead cells, culture filtrates, or cell extracts of the closely related strain will acquire and subsequently transmit a characteristic of the related strain. Only closely related strains of bacteria can be transformed.

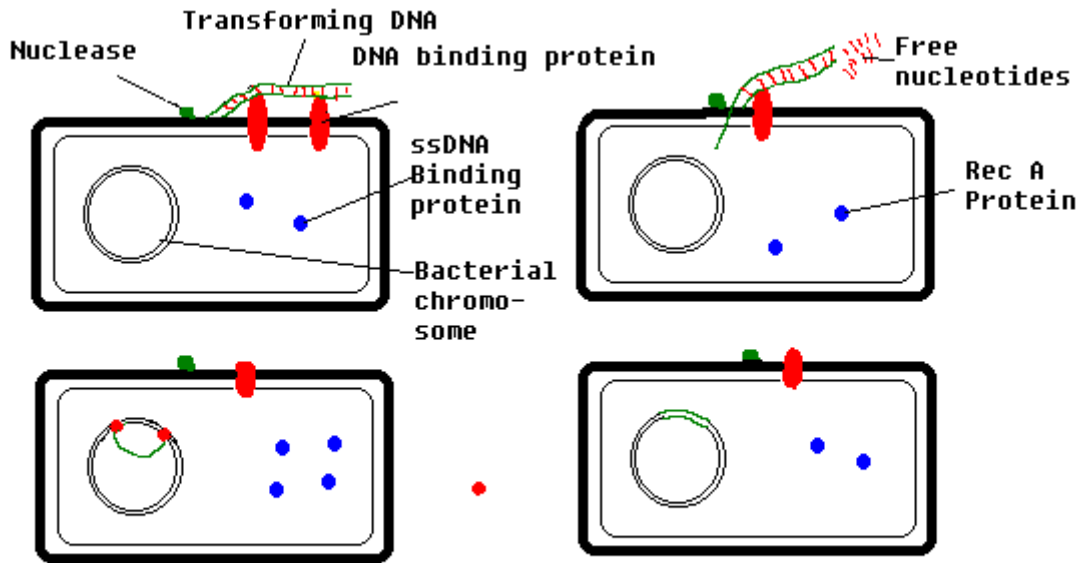

Other genera in which transformation is observed:

Bacillus, Haemophilus, Neissera, Rhizobium. During the late logarithmic phase of growth of the recipient cells, condition will be favourable for uptake of the donor DNA. During this period transformable bacteria are said to be competent.

GENETIC RECOMBINATION BY CONJUGATION:

Luria and Delbruck had demonstrated in 1943 that bacteria have a stable hereditary system but at that time there was no knowledge of any mating system in bacteria. The first demonstration of recombination in bacteria by conjugation was achieved by Lederberg and Tatum in 1946 by selecting two polyauxotrophic strains of *E. coli*. Prototrophs were produced due to recombination.

Fig-1

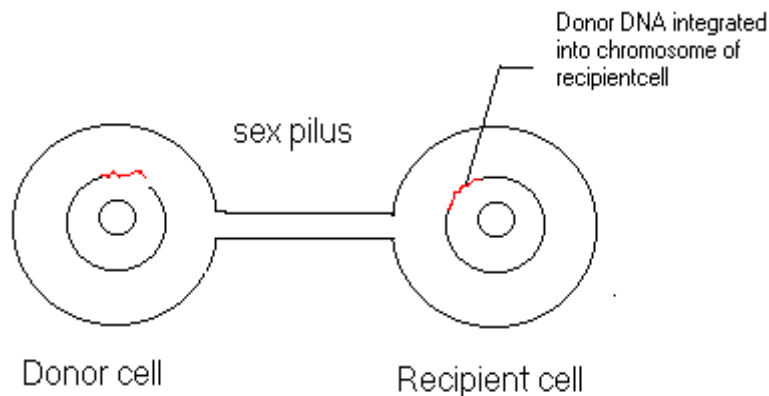

It is apparent that mating or conjugation in *E. coli* is radically different from sexual mating in higher organisms. It is not a reproductive process that occurs regularly at each generation. It does not involve meiosis since bacterial cells are haploid (no fusion of gametes). It involves the transfer of some DNA from one cell to another, and then mating pair will be separated. While only very small fragments of the bacterial chromosome are transferred in transduction and transformation. In conjugation, it is possible for the large transfer of large segments of the chromosome and in special cases the entire chromosome to be transferred.

Sex factors

A clearer understanding of conjugation in bacteria came about with the discovery that there is sexual difference in *E. coli*. Male cells contain a sex factor or 'F' factor (fertility factor), which is a small circular piece of DNA present in cytoplasm (that is not a part of the chromosome). The cells are called F^+ cells. The female cells do not have sex factor and are called F^- cells. Sex factor is responsible for the synthesis of one or more sex pili, tubular structures, through which F factor and DNA is introduced in F^- cell during mating of F^+ and F^- cells. The F^+ cells replicates the sex or F factor and a copy is always transferred to the F^- cell. Thus, an F^- cell usually becomes F^+ cell during mating. (Fig-2)

and F^- cells. The F^+ cells replicates the sex or F factor and a copy is always transferred to the F^- cell. Thus, an F^- cell usually becomes F^+ cell during mating. (Fig-2)

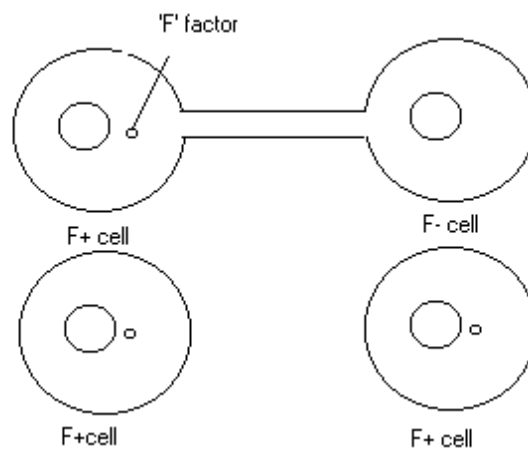

The transfer of F factor and F⁺ to F⁻ cell is almost certain, but the formation of recombinants in an F⁺ X F⁻ cross occurs at low frequency about one recombinant per 10⁴ to 10⁵ cells.

High frequency recombinant strains: (Hfr strains)

Hfr strains were isolated from F⁺ cells (Fig-3)

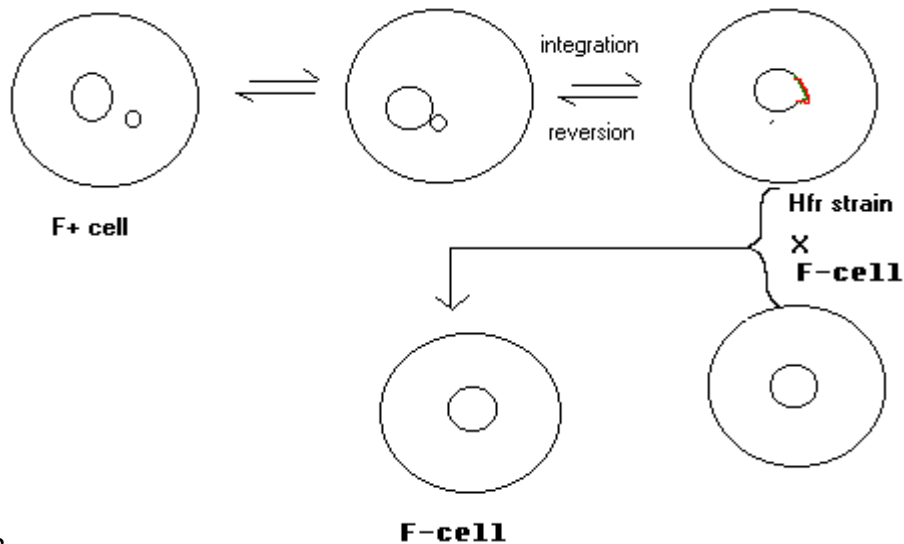

Fig -3

An Hfr cell arises from an F⁺ cell in which the F factor becomes integrated into the bacterial chromosome. During mating of Hfr and F⁻, the F⁻ cell almost always remains F⁻. This results because Hfr cell first transfers Hfr chromosome to F⁻ cell and rarely transfers sex factor. Hence, the recombination frequency is high. It takes about 100 minutes to inject a copy of the whole Hfr *E.coli* genome (normally 2-3 times of normal generation time of *E.coli*). Electron micrographs also revealed that some specific phages are adsorbed onto sex pilus during conjugation.

**B.Sc. Ag
II Sem**

Agricultural Microbiology

Credit - 2(1+1)

**As per ICAR
5TH Dean Syllabus**

**Download all BSc
Agriculture Notes from**
(Search on Google)

Bscagriculture.com

GENETIC RECOMBINATION BY TRANSDUCTION IN *SALMONELLA*:

Bacterial transduction is the transfer of a portion of DNA from one bacterium (a donor) to another (a recipient) by a bacteriophage.

Prophage: Viral genome of the temperate phages (which ordinarily do not lyse the cell) can become integrated into the bacterial genome. Just like the other episomes. These phages after integration are known as prophages.

Lysogenic bacteria:

The bacteria carrying prophages are called lysogenic bacteria. When the lysogenic bacteria are exposed to ultra violet light or some other agents, the prophages start replication and go through a lytic growth cycle. The phage particles will be released by the lysis of the bacterial cell. These new phage particles may become filled with cell chromosomal DNA or a mixture of chromosomal and phage DNA (rather than completely with phage DNA, as is normally the case). These new phages can introduce bacterial DNA when they infect new bacterial cells. Zinder and Lederberg discovered this phenomenon in 1952, when they searched for sexual conjugation among *Salmonella* species.

There are two types of transduction.

Generalized transduction and

Specialized transduction.

Generalized transduction:

If all fragments of bacterial DNA is i.e., from any region of the bacterial chromosome, have a chance to enter the transducing phase. The process is called generalized transduction. (Fig-4)

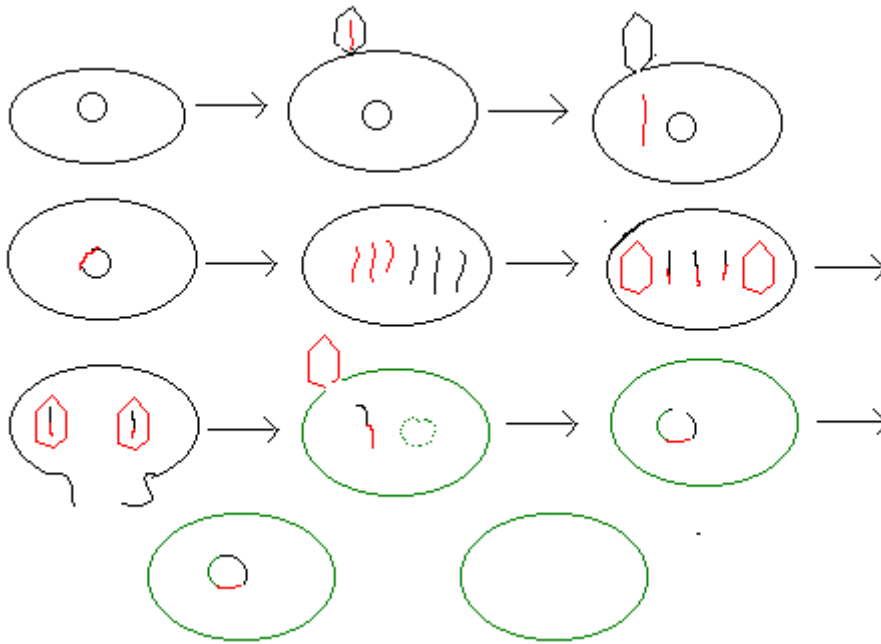

Specialized transduction: Certain temperate phage strains can transfer only a few restricted genes (Fig-5) of the bacterial chromosome.

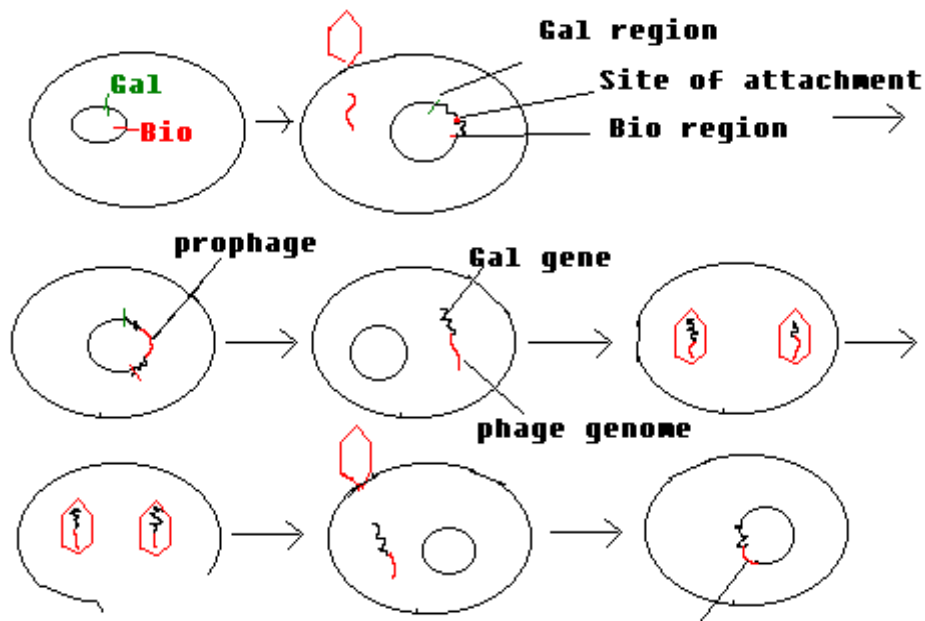

More specifically the phages transduce only those bacterial genes adjacent to the prophage in the bacterial chromosome. The process is also called as restricted transduction. Only 'Gal' gene can be transduced in the process.

Genetic engineering:

Refers to the development of organisms with genetic structure altered by manipulation. This kind of biochemical procedure is termed recombinant DNA technology and involves the use of plasmids and certain bacteriophages.

The result of gene recombination can be recognized only when there is recognizable change in structure or function of the cell. In other words, altered or added gene has to become operative if the resultant gene recombination to be functional. The expression of gene involves three well recognized processes namely, replication, transcription and translation.

Products from genetically modified strains of *E.coli*:

Insulin, interferon, urokinase (for the treatment of blood clot) and human growth hormone are produced by recombinant strains of *E. coli*.

The results of gene recombination can be recognized only when there is recognizable change in structure or function of the cell. In other words altered or added gene has to become operative if the resultant gene recombination to be functional. The expression of gene involves three well recognized processes namely, replication, transcription and translation.

Replication:

In molecular biology the production of a strand of DNA from the original strand is known as replication. Double stranded DNA on unwinding will be converted into two single strands. Each strand serves as a template for the synthesis of a new complementary chain, thus forming two new helices.

Template refers to the DNA (or RNA) chain that provides precise information for the synthesis of a complementary strand of nucleic acid. DNA replication is semi conservative. DNA is circular with out free ends in prokaryotes, viruses and organelles in eucaryotes. Linear in eucaryotes and many viruses.

Transcription:

The process in which a complementary single stranded mRNA is synthesized from one of the DNA strands is called transcription. The synthesis of polynucleotide chain of mRNA is catalyzed by the enzyme RNA polymerase and the activated ribonucleotides are the substrates for this enzyme.

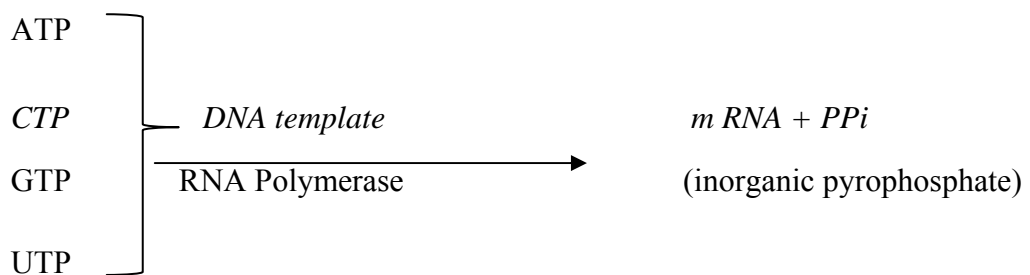

The synthesis of RNA is different from that of DNA in the following features:

- Only one of the two strands of any given segment of DNA serves as a Template.

- Only specific, relatively short lengths of DNA are transcribed, i.e. an RNA chain is a transcript of a short section of DNA.

Transcription is the first step in gene expression. This process involves separation of the two DNA strands, one of which serves as a template for the synthesis of a complementary strand of mRNA by DNA dependent RNA polymerase. When a short RNA chain is completed, the DNA double helix closes again. The strand of DNA selected for transcription in a given segment is called the “*Sense*” strand and contains a specific initiation site, which is a regulatory sequence of DNA nucleotides is called the *promoter region*. (The other strand may be the “Sense” strand for another group of genes in another segment). In bacteria, the initiation of RNA polymerase activity at this site is due to an initiation factor called the *sigma* factor, which is a component of the enzyme. Termination of mRNA synthesis is also at specific regulatory sequences of DNA nucleotides along the DNA molecules which are recognized by the RNA polymerase. Furthermore, a tetrameric protein factor called the *rho factor* binds to RNA polymerase and promotes its termination. When transcription has been completed, rho dissociates from the RNA polymerase-DNA complex.

Translation:

Translation is the next step in gene expression. It is the process in which the genetic information now present in the mRNA molecule directs protein synthesis. In the four different bases, the number of sequences of three of them is 4^3 , or 64. These base triplets, each of which specifies a particular amino acid, constitute the genetic code.

Translation involves three important steps:

1. Activation of amino acids
2. Formation of amino acyl tRNA synthetase with specific amino acid and
3. Synthesis of peptide on ribosomes.

GENETIC CODE:

Genetic code is triplet code the code is degenerate. UAA, UAG, UGA are non codons. AUG and GUG are the initiation codons. The code is probably universal for all species of living organisms.

Another distinctive property of the genetic code is that the same amino acid may be coded for by more than one codon; that is, the code is degenerate. Furthermore, no “*punctuation*” or signal is necessary to indicate the end of one codon and the beginning of the next. Therefore, reading frame, or the sequence in which the genetic code is deciphered, must be correctly set at the beginning of the readout of a mRNA molecule. Reading then moves sequentially from one triplet to the next one without pause. If the reading frame is incorrectly set in the beginning, all codons will be out of step and lead to the formation of a missense protein with a deranged(altered) amino acid sequence.

OPERON CONCEPT:

To synthesize a specific protein, an organism must also have structural genes for that protein on the chromosome. A structural gene determines the amino acid sequence of a protein molecule. Unlike the regulator gene, structural genes do not control the rate at which enzymes are produced. Genetic control of the rate of enzyme synthesis is directed by the regulator genes.

In many bacteria the structural genes governing the biosynthesis of proteins are positioned in the exact order of the sequence of reactions in the particular metabolic pathway. This means that the ordering the sequential reactions in the metabolic pathway is directed by the chromosome. A group of such consecutive genes forming an operational unit was named as **Operon** by Francois Jacob and Jacques Monod. The operon includes both the structural and associated regulatory genes. The regulatory genes function primarily at the level of transcription and not at the level of translation. Clustering of related genes provides a simple way of coordinating the response to a particular environmental change.

Regulation of enzyme synthesis:

This process is effected at the level of gene expression and is governed by induction and repression.

Regulation of gene expression:

It involves regulation at enzyme synthesis and enzyme activity inhibition. In bacteria regulation of gene expression occurs mainly at enzyme synthesis level by

Induction and repression of enzyme synthesis

Enzymes may be divided into two groups: Constitutive and inducible enzymes

Constitutive enzymes:

These are always produced by the cell. Some of the enzymes of glycolysis or sugar break down are constitutive enzymes. They are found in essentially the same amounts regardless of the concentration of substrates in the medium.

Inducible enzymes:

These are produced by the cell only in response to the presence of a particular substrate *i.e.* they are produced only when needed. The process is referred to as enzyme induction and the substrate responsible for evoking formation of the enzyme is an inducer.

Induction is the process that occurs when an inducer (the effector molecule), which is either the substrate or a compound related to the substrate or the enzyme-catalyzed reaction, is required for enzyme synthesis to occur. Repression is the process that takes place when a regulatory protein, the repressor, binds to a specific segment on the DNA called the operator, thereby preventing or repressing the synthesis of specific enzymes. In case of Regulation of enzymes involved in biosynthetic process, repression process involves effector molecules (corepressors) in addition to repressor molecules. Effector molecules, products or related compounds of the particular reaction, act as co-repressors in preventing synthesis of the enzyme. Co-repressors function by combining with the repressor to form an active complex, which combines with the operator gene to prevent messenger ribonucleic acid (mRNA) synthesis by the structural genes.

REGULATION OF ENZYME SYNTHESIS

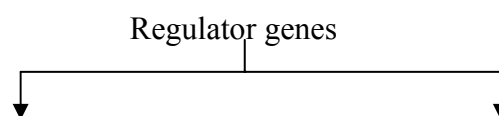

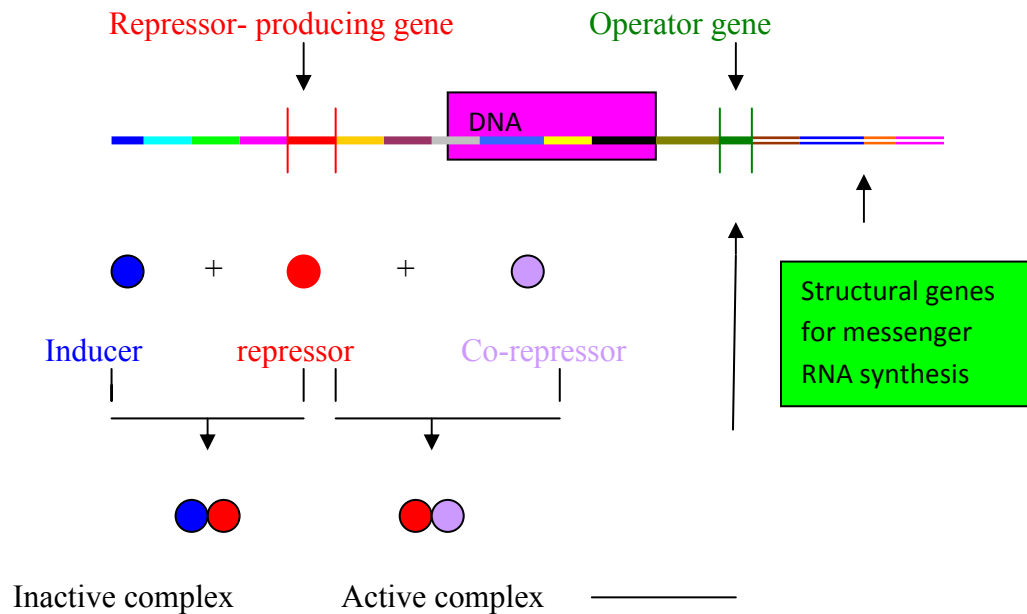

The repressors is also capable of combining with an inducer to form an inactive complex incapable of binding to the operator gene, in which case synthesis of mRNA can proceed. It is seen that the operator gene is one of the regulatory genes on a deoxyribonucleic acid (DNA) chromosome. As discussed above, the operator gene prevents gene expression by negative control. In other case, it can enhance gene expression by positive control. In this case the repressor binds to the inducer, undergoes a conformational change, and is converted into an activator, which triggers gene expression.

Lecture-19

LAC – OPERON IN *E.coli*

The operon consist of the following components:

Regulator gene, Promoter gene, operator gene, structural genes, repressor, co-repressor & inducers.

Structural genes :

The structural genes direct synthesis of cellular proteins through mRNA & determine the sequence of amino acids in the proteins synthesized. In lac-operon there are 3 structural genes z, y, a which transcribe one long polycistronic mRNA molecule. This controls the synthesis of 3 proteins β -galactosidase, galactoside permease & galactoside trans acetylase.

β - galactosidase splits lactose into glucose & galactose

galactoside permease facilitates the entry of lactose into cell

galactoside acetylase appears in small quantities upon lactose induction

Regulatory region :- It contains regulator, promoter and operator genes.

Operators gene:- The operator gene is adjacent to the first structural gene & controls the structural genes. It determines whether or not the structural genes are to be repressed by the repressor. The operator is recognized by the repressor protein which binds to the operator forming an operator – repressor complex.

The basic function of the operator is that on binding the repressor it physically prevents RNA polymerase from forming an initiation complex.

Promoter gene:-

RNA polymerase binds to DNA at the promoter site and increases transcription & protein synthesis

LAC OPERON CONCEPT

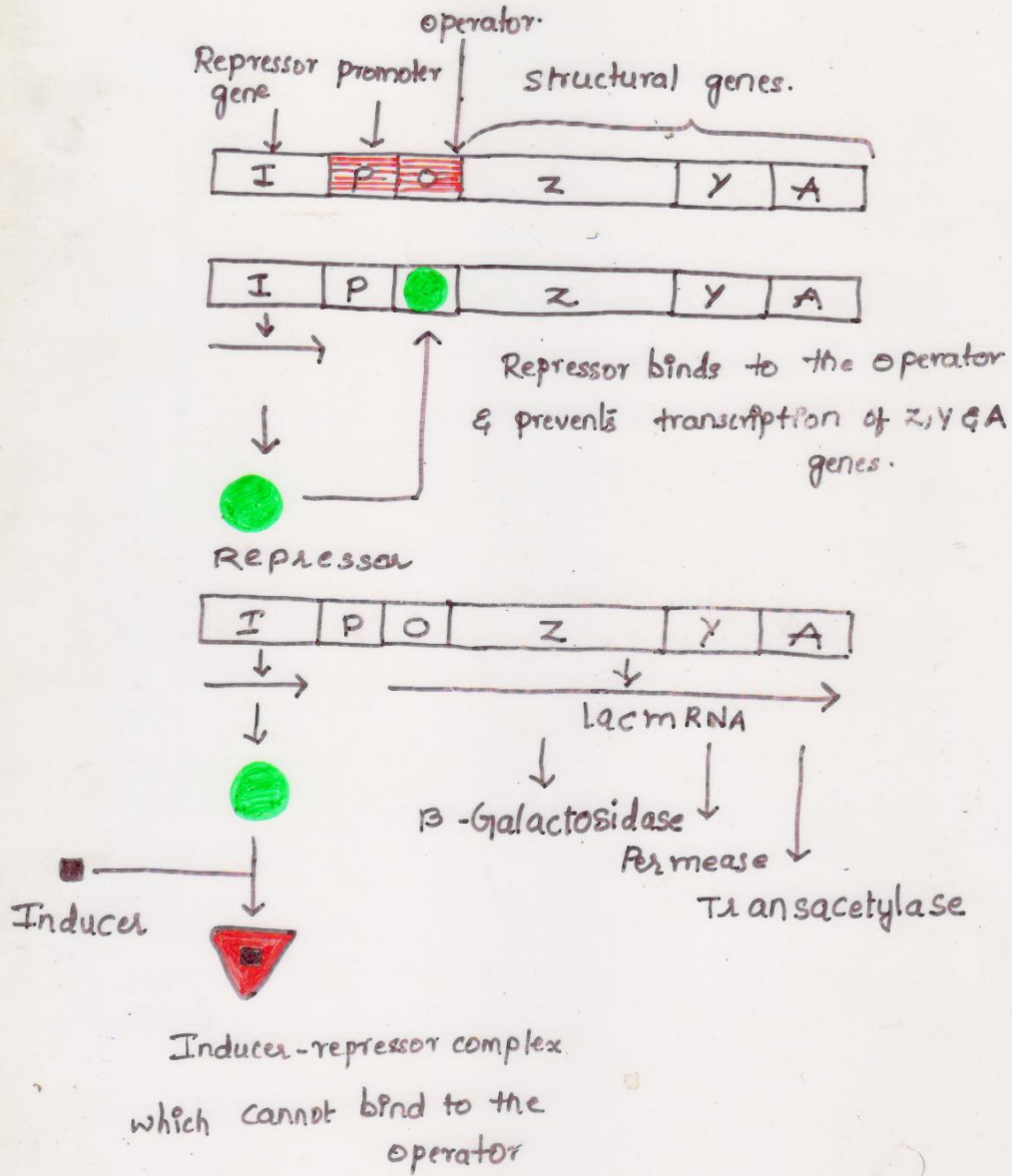

Regulator gene:-

The regulator gene directs the synthesis of a protein which may be an active repressor or an inactive repressor (aporepressor)

The control of protein synthesis by regulator protein may be by induction or repression. They may also be negative or positive control.

Induction:-

Inducible enzymes are normally absent in the cell or are present in very small quantities. They increase in quantity only in the presence of an inducer. Such a system is called as inducible system.

A bacterial culture of *E. coli* growing in a medium with glucose as the source of carbon produces only minute quantities of the β - galactosidase enzyme. Only 1 or 2 molecules of the enzyme are present. When lactose is added to the medium the production of β -galactosidase starts, & within 2 or 3 minutes about 3000 molecules are synthesised by the z gene. β - galactosidase hydrolyses lactose into the sugars galactose & glucose some galactose & glucose molecules are converted into allo lactose, which is the inducer for β - galactosidase synthesis.

When the inducer is absent the active repressor protein produced by the regulator gene associates with the operator gene & blocks it. No transcription of mRNA by the structural genes & hence there is no enzyme synthesis. Absence of the inducer may be due to not present in the growth medium or is not synthesis by the microorganism.

When the inducer is present the active repressor binds to the inducer molecule to form a repressor – inducer complex (R-I). A conformational change takes place in the repressor molecule, which is inactivated. This prevents binding to the operator, which is therefore not blocked. The structural genes transcribe mRNA & enzyme synthesis takes place.

Negative control of 'Lac' operon

It has been seen that both in the inducible & repressible systems. Protein synthesis takes place when the operator genes is free & stops when it is blocked. Gene expression

therefore only takes place when operator gene is free. Such a control mechanisms for protein synthesis is of negative type.

An example of negative control is the induction of protein synthesis in presence of lactose & absence of glucose by the lac-operon of *E.coli*. In negative control the regulator protein is the repressor & it prevents gene transcription. In inducible system the effector molecule is the inducer. The inducer prevents repressor function & this enables gene transcription & protein synthesis. In the repressible system the effect or molecule is co-repressor. The co-repressor stimulates repression & prevents gene transcription

Positive control of Lac operon:

In positive control transcription does not takes place unless the regulator protein is bound to the operator. Such regulator protein are called activators. Activators believed to change DNA confirmation in the transcription initiation region in such a way that RNA polymerase initiates transcription efficiently.

Positive control:-

In inducible system, the activator is in inactive state & cannot bind DNA. When an inducer molecule interacts with the activation the activator becomes active & binds DNA. This permits transcription of operon. The catabolite sensitive operons of *E.coli* show inducible positive regulation.

Catabolite sensitive operons are repressed by accumulation of breakdown products (catabolites) of various carbon compounds, eg. Glucose. These operons are concerned with utilization of those energy sources that are used only when glucose is absent from medium. The effect of catabolites on these operons is mediated by cAMP (cyclic adenosine monophosphate), which acts via a protein called catabolite activator protein (CAP), these operons are transcribed only when CAP binds to a region of their promoters. But CAP can bind DNA only when it is associated with cAMP.

When glucose is absent from medium, the cells have cAMP above a threshold concentration. Therefore CAP interacts with cAMP & binds to DNA, this enables transcription of catabolite sensitive operons.

In the presence of glucose in the medium, it is preferentially used by cells. This is because glucose somehow reduces cAMP level in the cell below the threshold level needed for CAP activation. As a result, CAP is unable to bind the promoter of 'Catabolite sensitive' operons & they are not transcribed.

Inducible positive control of Lac-operon of *E.coli* :

- (A) CAP interacts with cyclic AMP, this allows CAP and RNA polymerase to bind to the promoter & begin transcription.
- (B) In the absence of cyclic AMP, CAP is unable to bind to the promoter. As a result, RNA polymerase cannot attach to the promoter & transcription cannot begin even if the operator is free from the repressor.

Glucose (present) → used by cells → Glucose (6)
 → reduces CAMP level below threshold level (CAP
 Activation)
 → CAP → unable to bind promotor
 ↓
 Not transcribed.

Inducible positive control of lac-operon of E. coli

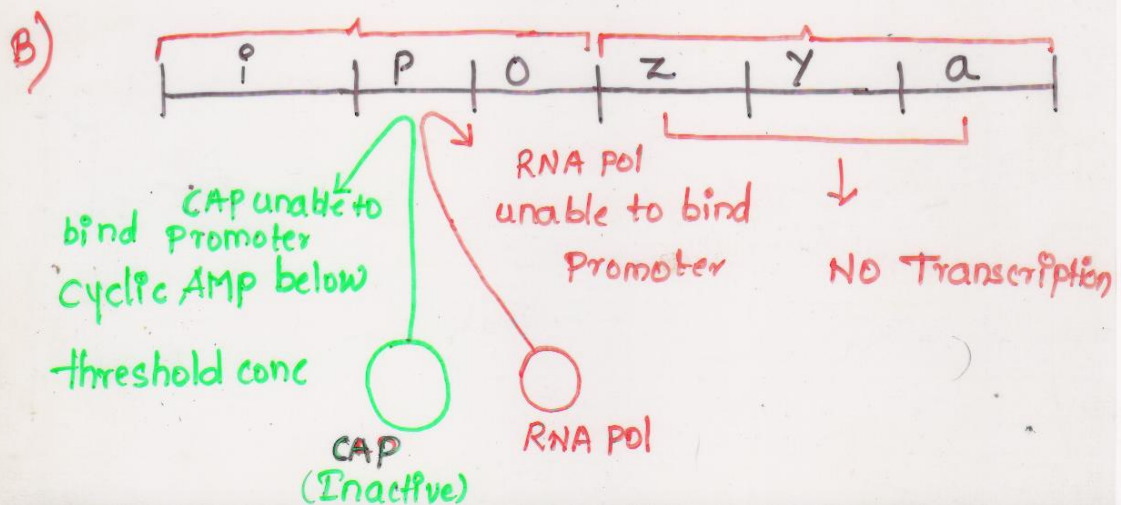
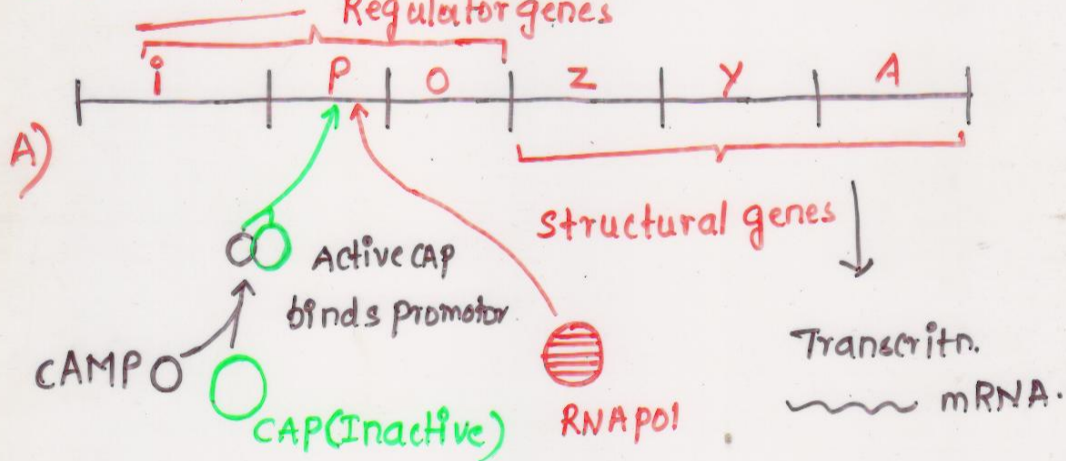

SOIL – MICROBIOLOGY

The soil consists of five major components. They are living organisms, organic matter, air, water and minerals. The soil is generally referred as the loose material of the earth's surface, which supports the growth of plants, bacteria, fungi, algae and protozoa, which make up for the living organisms of soil.

Fertile soil is inhabited by the root systems of higher plants, by many animal forms (ex: insects, worms) and by the tremendous number of microorganisms. The type and quantity of microorganisms present in a soil vary depending upon the physical characteristics and agricultural practices and other parameters such as amount and type of nutrients, available moisture, degree of aeration, temperature and pH. Soil has great variety of microorganisms of bacteria, fungi, algae, protozoa and viruses.

IMPORTANT GROUPS OF MICROBES AND THEIR ROLE IN FERTILITY OF SOIL AND PLANT GROWTH

Microbial population in a fertile agricultural soil

<u>Type</u>	<u>Number per gram</u>	
Bacteria	2,500,000,000	(2.5 X 10 ⁹)
Actinomycetes	700,000	(7.0 X 10 ⁵)
Fungi	400,000	(4.0 X 10 ⁵)
Algae	50,000	(5.0 X 10 ⁴)
Protozoa	30,000	(3.0 X 10 ⁴)

Bacteria:

The bacterial population of the soil exceeds population of all other groups of microorganisms in both number and variety. The types of bacteria that are present in the soil are autotrophs, heterotrophs, mesophiles, thermophiles, psychrophiles, aerobes, anaerobes, cellulose digesters, protein digesters, sulfur oxidizers, nitrogen fixers and others.

Fungi:

Hundreds of different species of fungi are present in the soil. They are most abundant in the surface soil. They decompose cellulose, lignin, and pectin. The physical structure of soil is improved by the accumulation of mold mycelium within it. Yeasts are more prevalent in soils of vineyards and orchards.

Algae:

Population is smaller than bacteria and fungi. Mostly they are present on surface or subsurface of the soil. The major types present are green algae and diatoms. The growth and activity of the initial algae and bacteria paved the way for the growth of other bacteria and fungi. The cyanobacteria play a key role in the transformation of rock to soil.

Protozoa:

Most soil protozoa are flagellates or amoebas. Their dominant mode of nutrition involves ingestion of bacteria and may be a factor in maintaining some equilibrium of microorganisms in soil.

Viruses:

Bacterial, plant and animal viruses find their way into soil, through additions of plant and animal wastes. The microbial population in the rhizosphere is considerably higher than that of root free soil and physiologically more active since they make use of the root extracts.

Soil microorganisms serve as biological agents for the conversion of complex organic compounds into simple inorganic compounds or into their constituent elements. The overall process is called mineralisation. Soil microbes also fix or remove inorganic ions or mineral and this process is known as immobilization. Both immobilization and mineralisation are important for recycling of various nutrients required by plants and animals. The major nutrients essential for plant growth are C, H, O, N, P, K and S. Many of these elements undergo constant transformations in soil through the processes of immobilization, mineralisation, oxidation, reduction etc. by the soil microorganisms.

Rhizosphere:

Rhizosphere can be defined as the region extending a few millimeters from the root surface in which the microbial population of soil is influenced by the chemical activities of plant roots. The rhizosphere differs from the bulk soil because of the activities of plant roots & their effect on soil organisms

A major characteristic of the rhizosphere is the release of organic compounds into the soil by plant roots. These compounds called root exudates makes the environment different in rhizosphere and bulk soil. The exudates increase the availability of nutrients in the rhizosphere & also provide a carbon source for heterotrophic microorganisms. The exudates cause the no. of microbes to be far greater in the rhizosphere than in the bulk soil. The population of organisms in the rhizosphere can be 500 times higher than in bulk soil.

Organisms in the rhizosphere can affect the plant roots by altering the movement of carbon compounds from roots to shoots. Many microorganisms are beneficial and are called Plant growth promoting rhizobacteria(PGPR). Various root microbes association can increase nutrient uptake by plants in nutrient poor environment such as symbiosis (eg. Mycorrhizal or Rhizobia) & specific association (Associative N₂ fixing bacteria with grasses etc – *Azospirillum*) . Some microorganisms produce hormones that stimulate plant growth and some microorganisms are antagonistic to plant pathogens. But some soil microorganisms are pathogenic & attack living plant roots.

Rhizoplane:-

The rhizoplane is the surface of the plant roots in the soil. The rhizoplane is the site of the water & nutrient uptake & the release of exudates in to the soil. As roots grow they cast dead cells & navigate around the soil particles making the rhizoplane highly irregular, blurring the dividing line between the root surface & soil.

Phyllosphere:

The region on the leaf surface where microorganisms are present abundantly. The leaf surface microbes may perform an effective function in controlling the spread of air borne microbes inciting plant disease. Resistance to disease causing microbes has also been attributed to fungistatic compounds secreted by leaves such as malic acid etc.

Phyllosphere bacteria are often pigmented due to direct solar radiation. Any change in phyllosphere, affects plant growth which in turn affects the physiological activity of root system. Such changes in the root results in an altered pH & spectrum of chemical exudation causing a change in rhizosphere microflora. Thus there is a link between phyllosphere microflora and rhizosphere microflora. There is a continuous diffusion of plant metabolites from leaves which support the microbial growth & in turn these microbes protect the plant from pathogens.

Lecture - 21

CARBON CYCLE

The carbon is one of the most important elements in biological systems and a component of all cell structures, which constitute about 50% of all living organisms. The carbon undergoes different oxidation – reduction states cyclically by processes known as photosynthesis, respiration, etc. The carbon cycle revolves around CO₂ fixation and its regeneration.

The ultimate source of organic carbon compounds in nature is the CO₂ present in the atmosphere (or dissolved in water). The CO₂ in the atmosphere is fixed both autotrophically and heterotrophically. Green plants and algae are the most important agents of CO₂ fixation. Bacteria are also capable of synthesizing organic compounds utilizing inorganic CO₂ in the atmosphere.

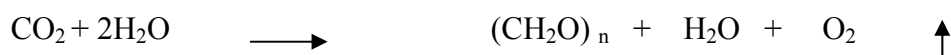

CO₂ fixation also takes place in some heterotrophic microorganisms



Pyruvate

Oxaloacetate

Under anaerobic conditions, phototrophic bacteria fix CO₂ by utilizing H₂S or organic compounds as a source of electrons.



MICROBES INVOLVED IN REDOX CYCLE FOR CARBON

The organic carbon compounds that are eventually deposited in the soil are degraded by microbial activity, CO₂ is released in to the air and soil. Top six inches of fertile soil contains approximately 2 tonnes of fungi and bacteria per acre whose metabolic activity equals to nearly tens of thousands of human beings. The large surface to volume ratio of microorganisms enhance rapid exchange of substrates and waste products from the environment. Any one particular genus has a limited capacity to degrade numerous compounds present in nature but a variety of different genera of microbes together would nearly degrade almost every compound occurring in nature. Nearly 90% of CO₂ in the atmosphere is accounted for by the release of CO₂ on decomposition and respiration of organic compounds by bacteria and fungi.

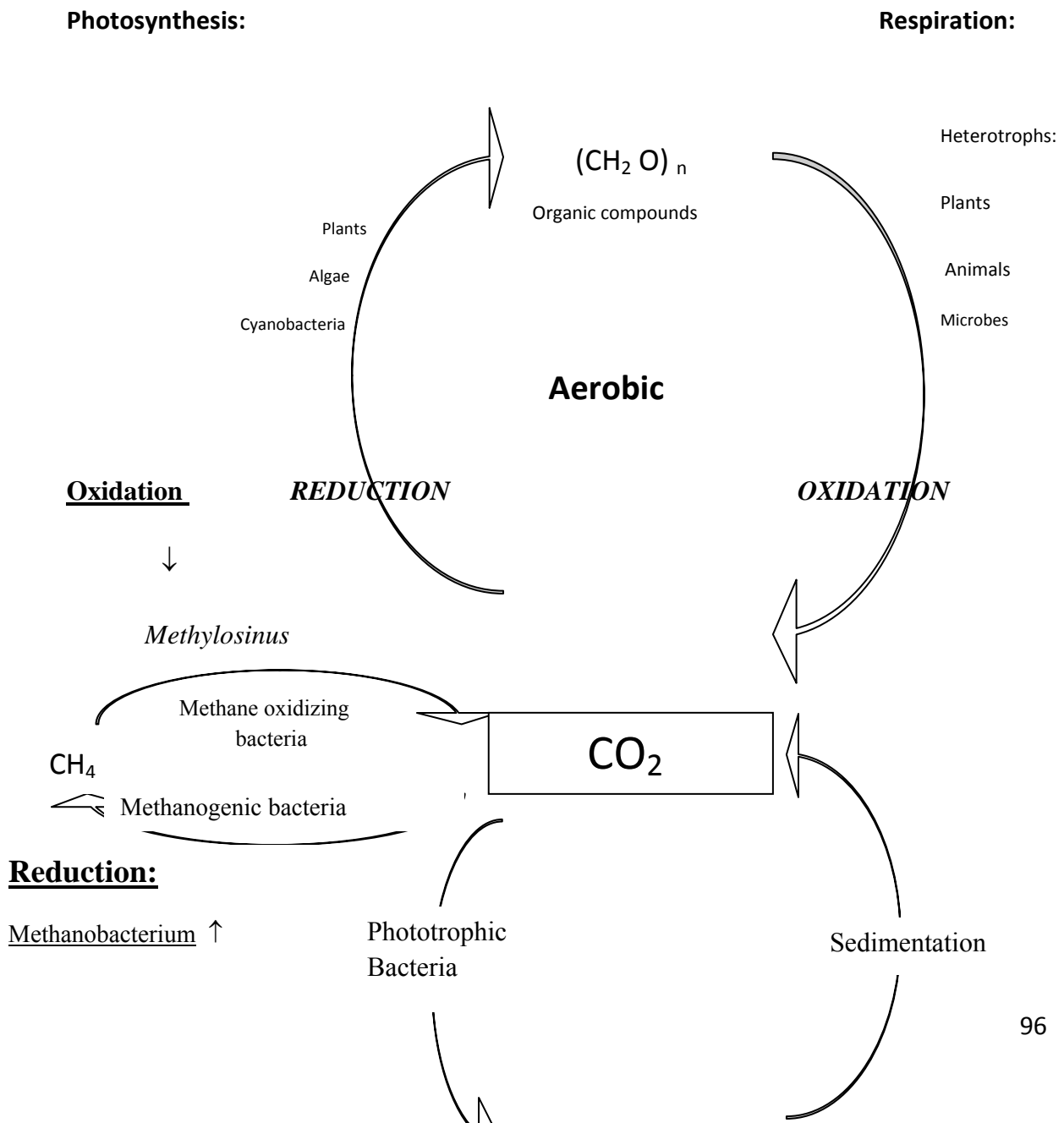

Anaerobic

Green sulfur bacteria

Purple sulphur bacteria

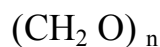

Green non sulfur bacteria

Organic compounds

D Purple non sulphur bacteria **by microorganisms:**

M egradation of organic carbon sugars, amino acids, lipids, fatty acids, starches, celluloses, hemicelluloses, and lignin. Lignin is decomposed very slowly.

Bacteria: *Cellulomonas*, *Bacillus*, *Clostridium*, *Pseudomonas*, *Erwinia*, *Micrococcus*, *Arthrobacter*, *Xanthomonas*, etc.

Actinomycetes: *Streptomyces*, *Nocardia*, *Thermonospora*, *Actinomyces*, etc.

Fungi: *Trichoderma*, *Aspergillus*, *Penicillium*, *Fusarium*, *Rhizoctonia* etc., .

Methanogenic bacteria produce CH_4 from $\text{CO}_2 + \text{H}_2$ and from organic acids such as acetic acid produced fermentatively by anaerobic bacteria. Methane is oxidized further to CO_2 by methane oxidizing bacteria. The process of CH_4 production is an important biochemical process, which is made use of in production of biogas by the degradation of sewage, domestic waste and various agricultural wastes.

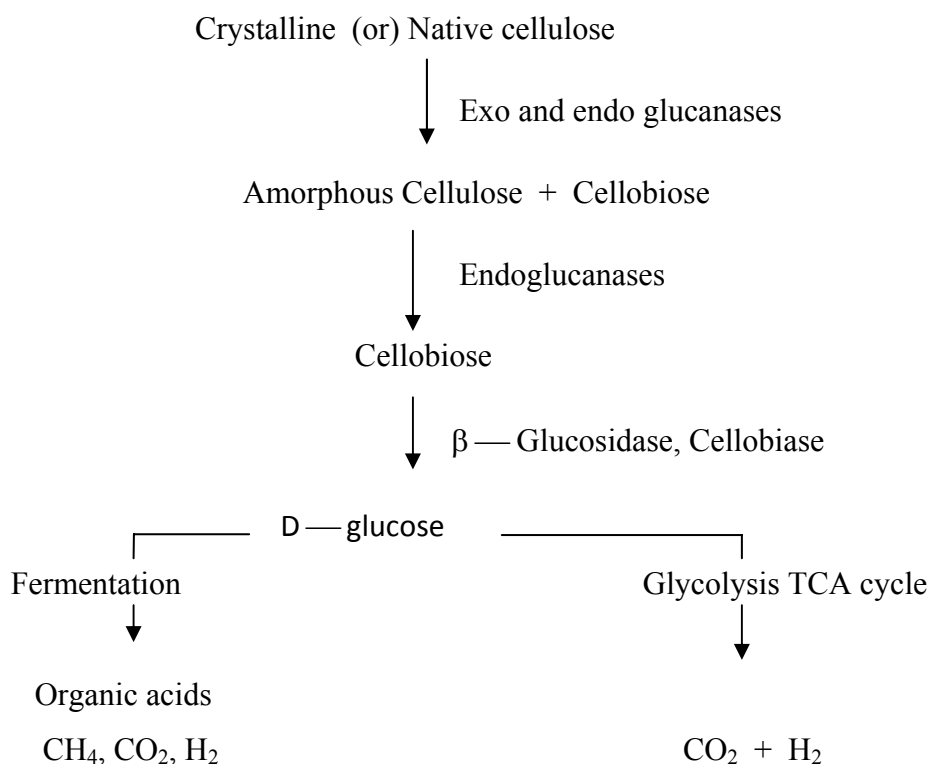

NITROGEN CYCLE

The element nitrogen is a key element of protoplasm of living cells. It exists in a number of oxidation states. Several of the redox reactions of N are carried out solely by microorganisms and the microbial involvement in the nitrogen cycle is of great importance. Thermodynamically N_2 gas is the most stable form of nitrogen. Molecular N_2 constitutes about 78 % of earth's atmosphere. This form is chemically inert and cannot be utilised by most living organisms. Plants, animals and microorganisms depend on a source of combined nitrogen such as NH_3 , NO_3^- or organic N compounds for their growth. A part of atm. N_2 is converted into a reduced form and further into an organic form by certain free living bacteria and by some plant-microbe associations.

The nitrogen cycle mainly involves transformations such as

I) Nitrogen mineralization in which nitrogen complexes are decomposed into simpler or organic forms and converted into inorganic compounds for use by plants

II) Nitrogen immobilization in which nitrogen compounds are assimilated into cellular materials.

Nitrogen Mineralization:

In the process of mineralization, proteins, nucleic acids and their components are degraded by microorganisms with the eventual liberation of ammonia and this is called ammonification. A part of the liberated ammonia is assimilated by the microorganisms themselves. The first step in the process of ammonification is the hydrolysis of proteins, nucleic acids and other organic nitrogenous compounds into amino acids (proteolysis). The amino compounds are then de-aminated to yield ammonia. Ammonification usually occurs under aerobic conditions. Protein decomposition leads to conversion of ammonia into amines and related compounds. These amines are subsequently oxidized in the presence of oxygen to release ammonia. In nature, the breakdown of nitrogenous substances is brought about by the activity of a multitude of microbial species. Almost all

bacteria, actinomycetes and fungi can bring about proteolysis and the amino acids so produced are utilized for the growth of these organisms.

NITROGEN CYCLE

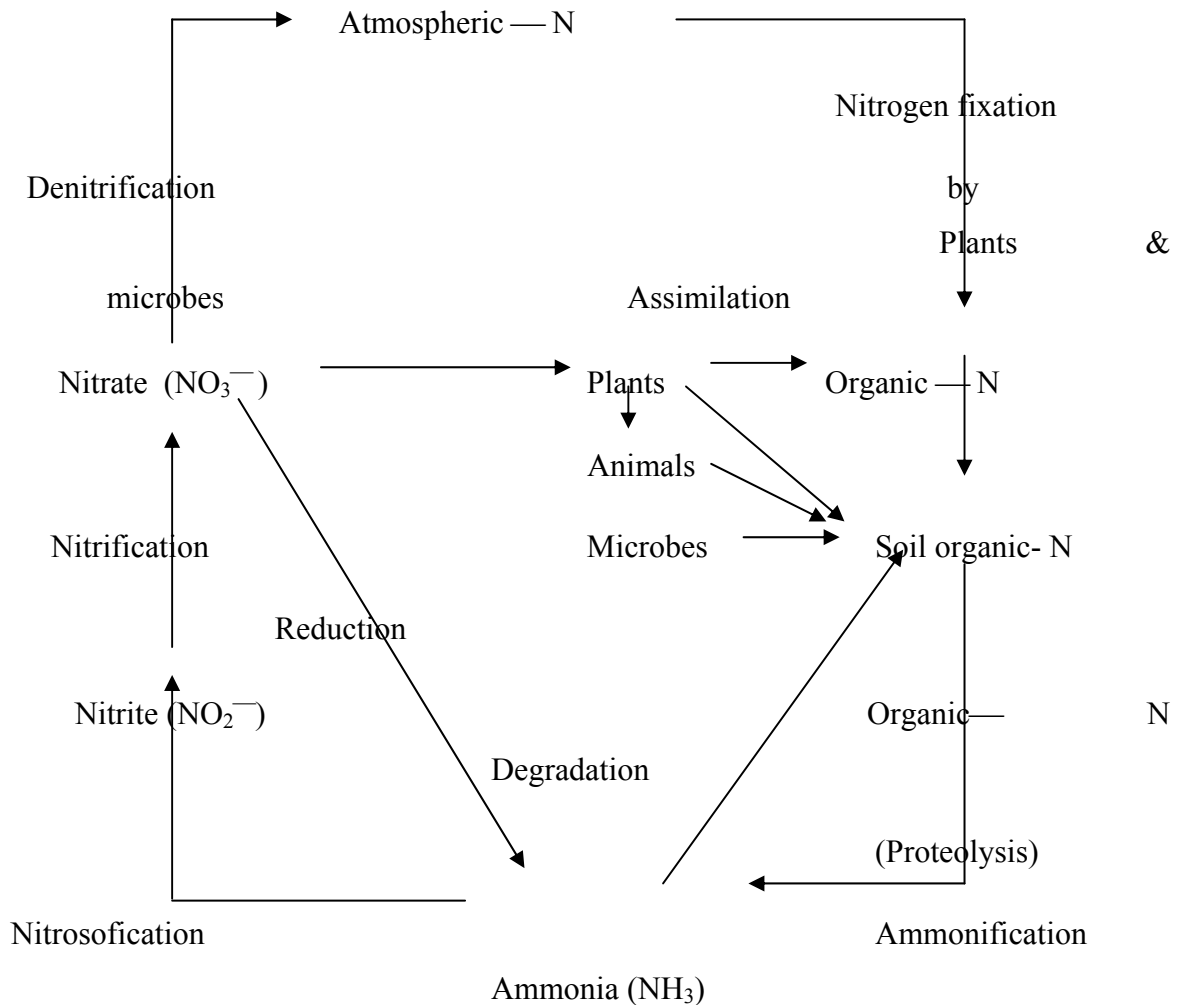

Nitrogen immobilization:

When plant residues or pure carbohydrates are added to the soil, there is a rapid decrease in the amount of available inorganic nitrogen which is referred as “nitrogen immobilization”. It results from the microbial assimilation of inorganic nitrogen. The process of immobilization involves the incorporation of ammonia and nitrate into microbial protein and nucleic acids and is therefore the reverse of mineralization. Mineralization and immobilization therefore run counter to each other. On the death of microorganisms, the immobilized nitrogen is however, released through mineralization.

Nitrification:

In the second phase, ammonia is converted into nitrate and this process is called nitrification. Nitrification occurs in two steps; first, ammonia is oxidized to nitrite:

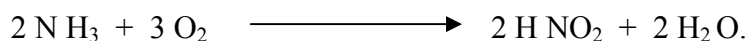
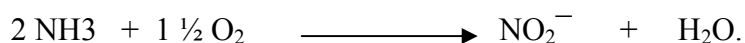

This change is brought about by chemoautotrophic bacteria of the genera *Nitrosomonas*, *Nitrosolobus*, *Nitrosococcus* and *Nitrospira*. These bacteria obtain their energy requirement by the oxidation of NH_4^+ to NO_2^- . Of these nitrifying organisms, *Nitrosomonas* are the most important in the soils.

Besides the chemoautotrophic bacteria, some heterotrophic bacteria such as *Streptomyces* and *Nocardia* have also been known to oxidize ammonia to nitrite.

Nitrosomonas, first converts ammonia to hydroxylamine which is then transformed into some undefined intermediate, possibly a compound such as nitroxyl (HNO). This intermediate is then oxidized to nitrite possibly by way of Nitrous oxide as shown below:

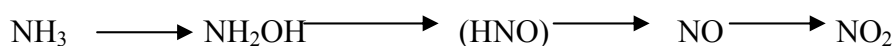

In the second step, nitrite is oxidized to nitrate:

Nitrobacter oxidizes nitrite to nitrate and yields two electrons for each molecule of NO_2^- transformed..

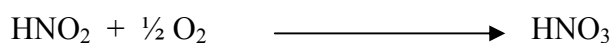

Certain fungi belonging to the genera *Aspergillus*, *Penicillium* and *Cephalosporium* can also carry out nitrification.

Denitrification

Certain bacteria are capable of using nitrate as the terminal electron acceptor under anaerobic conditions. Nitrate is reduced to nitrogen gas or nitrous oxide. This process is called as denitrification and leads to the loss of nitrogen from the soil. Denitrification depletes the soil of an essential nutrient for plant growth and therefore is not a desirable reaction. Denitrification occurs mostly in waterlogged anaerobic soils with a high organic matter content and the ability to carry out denitrification is restricted to only certain bacteria.. Among the bacteria important in denitrification are *Thiobacillus denitrificans*, *Micrococcus denitrificans* some species of *Pseudomonas*, *Bacillus*, *Paracoccus*,

Achromobacter and *Serratia*. The enzymes involved in various steps of denitrification reactions are called as nitrate, nitrite, nitric oxide and nitrous oxide reductases. The overall reaction is :

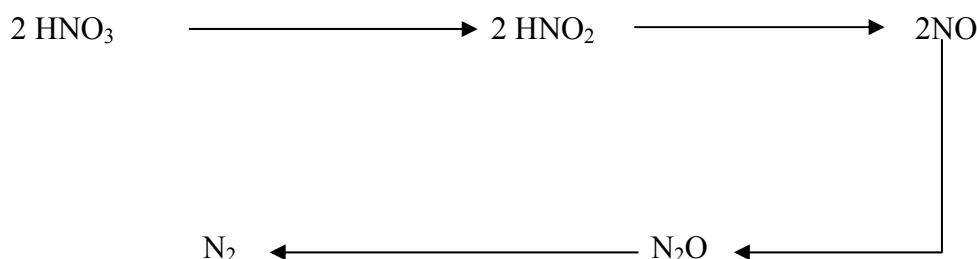

Nitrate is first reduced to nitrite which is then transformed to NO. The NO is converted to N₂ with N₂O as intermediate.

Although denitrification is an undesirable reaction from the point of view of plant nutrition, the supply of nitrogen on the earth would have got depleted and NO₃⁻ would have accumulated. Also, since high concentration, of NO₃⁻ are toxic, denitrification is a mechanism by which some of the nitrogen is released back to the atmosphere.

BIOLOGICAL NITROGEN FIXATION:

A variety of procaryotic organisms are known to have the ability to reduce atmospheric nitrogen and fixation of the inert atmospheric elemental nitrogen by microorganisms through a reductive process called “Biological Nitrogen Fixation”.

The conversion of molecular nitrogen into ammonia by microorganisms is known as Biological nitrogen fixation. In 1838, Boussingault showed that leguminous plants can fix atmospheric nitrogen and increase the nitrogen content of the soil. This observation led to better understanding of the practice of crop rotation involving legume crops. Beijerinck later identified the bacteria that are associated with roots of leguminous plants as Rhizobia. By the end of 19 th century, many free living aerobic and anaerobic bacteria were found to have the ability to fix atmospheric N₂ the associative symbionts are a new class recognized recently to have the ability to fix atmospheric N₂ in association with the roots of grasses and cereal plants. Several free-living blue green algae were found to fix

atmospheric N₂. It was estimated that global – N input was nearly 2.6 X 10¹¹ Kg N per year with biological nitrogen fixation processes contributing for nearly 70%.

Nitrogen fixation on earth’s surface through various processes

Nitrogen fixing system	Quantity of N fixed X 10 ⁶ Metric tonnes / year
Industrial nitrogen fixation	50
Atmospheric (lightening)	10
Combustion (Industry, automobiles etc.)	10
Ozonization	10
Biological nitrogen fixation	170

In symbiotic systems biological nitrogen fixation leads primarily to ammonia formation which is assimilated into plant proteins. In non- symbiotic systems first N₂ is converted to microbial proteins and after the death of microbes, proteins decompose, nitrification takes place and then NO₃⁻ will be taken up the plants.

The enzyme, nitrogenase, which reduces atmospheric N₂ to 2NH₄⁺, has been found to be present in all most all of the nitrogen-fixing bacteria. This enzyme has been fairly well characterized and the enzymes from different systems have common properties allowing a unified description of a single nitrogenase. Nitrogenase contains two components. Component - I is designated as Mo-Fe protein (nitrogenase) and component-II is designated as Fe–protein (nitrogenase reductase). Both the components are oxygen sensitive. Mo-Fe protein consists of 4 sub–units whereas Fe protein consists of 2 sub–units.

The essential reactants in the bacterial nitrogen fixation process are

1. Components I & II
2. A strong reducing agent,
3. ATP molecules,
4. A regulating system for NH₃ production and utilization,
5. A system that protects the N₂ fixing system from inhibition by O₂.

Mineralisation and immobilization:

The plants utilize phosphate ions and synthesize organic phosphates within the cell. The organic phosphorus of plants, animals and microorganisms is released by enzymatic hydrolysis by phosphatases released by soil microflora. These enzymes show a broad range of specificity and are grouped into two groups based on their pH optima, the alkaline phosphatases and the acid phosphatases.

Solubilization

Phosphate becomes limiting for plants growth because much of the phosphorus is in the bound form in the soil as insoluble Ca_2^+ , Fe_2^+ or Al^{+3} phosphates. Microorganisms produce various organic and inorganic acids and there by solubilize insoluble phosphates. Some of the fungi and a number of bacteria found in soil produce these acids and make the insoluble phosphorus available to the plants in the form of phosphates.

Ex:-The species of *Bacillus*, *Pseudomonas*, *Micrococcus*, *Flavobacterium*, *Phosphobacterium*, *Aspergillus*, *Penicillium*, *Fusarium* and others.

Several fungi that associate with plant roots are *Mycorrhizae*, and they help in phosphorus uptake. Some of the bacterial preparations are used as phosphatic biofertilizers for solubilisation of phosphorus in soils rich with insoluble phosphates.

PHOSPHOROUS CYCLE

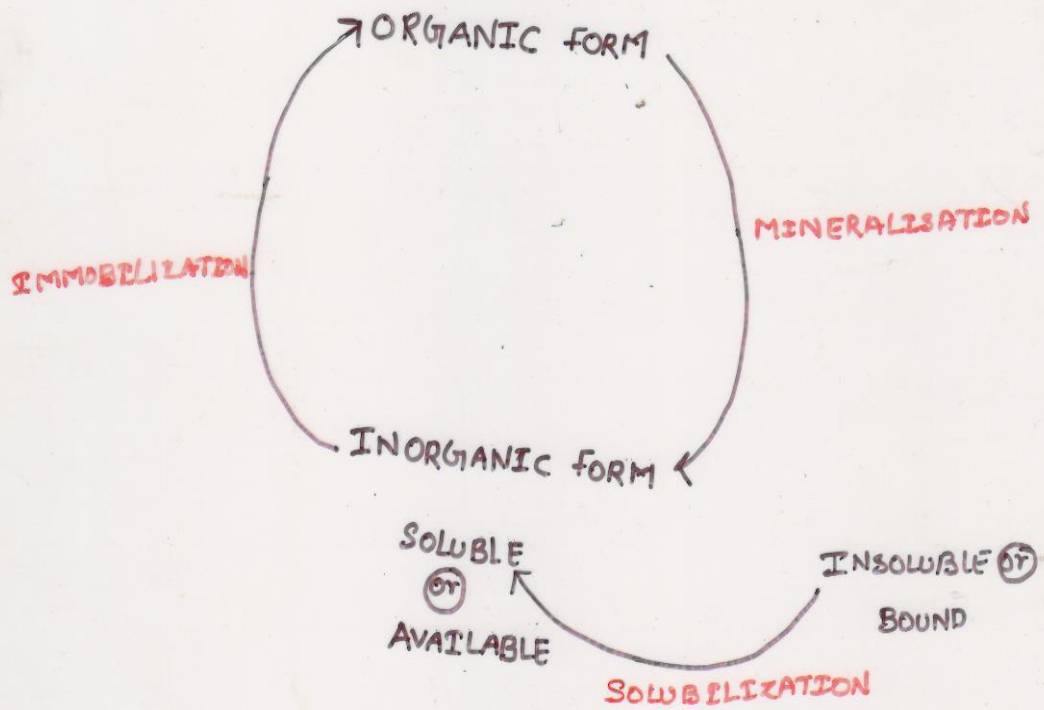

SULPHUR CYCLE

Sulfur transformations are even more complex than those of nitrogen due to the variety of oxidation states of sulfur. Some sulfur transformations occur at significant rates chemically as well as biologically. To be useful, sulfur has to be first oxidized or reduced in the soil. It occurs both in organic (sulfur amino acids and vitamins) as well as in inorganic form (S , H_2S , SO_4^{2-} , etc) and is readily metabolized. These transformations are

1. Decomposition of larger organic sulfur compounds to smaller unites and their conversion into inorganic compounds
2. Microbial associated immobilization
3. Oxidation of inorganic ions and compounds such as S_2^- , $S_2O_3^{2-}$, S
4. The reduction of SO_4^{2-} and other ions to sulphides.

Plants utilize sulfur in the form of sulphates and reduce to H_2S within cells to be utilized in synthesis of amino acids, vitamins etc. Animals obtain their sulfur by feeding on plants. When plant, animal and microbial proteins are degraded, the sulfur is released from amino acids and accumulates in the soil. This is further oxidized to SO_4^{2-} under aerobic conditions. Under anaerobic conditions the sulfur accumulated in the soil is converted to H_2S .

The biological oxidation of elemental sulfur and inorganic sulfur compounds such as H_2S , SO_3^- and $S_2O_3^{2-}$ is brought about by chemoautotrophic and photosynthetic bacteria. The oxidation of H_2S is characteristic of pigmented photosynthetic bacteria, which use H_2S as an electron donor in photosynthesis. Members of *Thiobacillus* genus oxidize elemental S . Heterotrophic bacteria actinomycetes and fungi are also reported to oxidize sulfur compounds. *Bacillus*, *Pseudomonas*, *Arthrobacter* and *Flavobacterium* oxidize



Under anaerobic conditions,

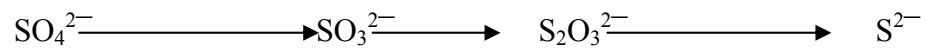

Bacillus, *Pseudomonas*, *Desulfovibrio* reduce SO_4^{2-} to H_2S .

Dissimilation of S as H_2S and its release into the atmosphere far exceeds the total amount of H_2S produced from all other pollution sources.

Lecture 24

WATER MICROBIOLOGY

Water is obtained either from surface sources such as rivers, lakes or from underground. Natural waters are likely to be polluted.

Water born diseases:

Although water purification systems envisage protection from pollution, sometimes, the water supply can become a potential carrier of pathogenic organisms and endanger public health. A number of diseases such as cholera, typhoid, viral hepatitis etc. are known to be water borne. These pathogens are commonly transmitted through drinking water and cause infection of the intestinal tract. It is therefore, necessary to employ treatment facilities to purify water and to provide safe drinking water (potable water).

Water standards:

WHO (World Health Organization) standards of water

Purpose	Maximum number of Total bacteria /100ml 100ml	permissible coliforms /
Irrigation water 100ml		< 100 coliforms /
Aquaculture 100ml	< 10 ⁴	< 10 coliforms /
Food industry	10	< 5 coliforms / 100ml
Drinking water 100ml	10	2 to 5 coliforms /

Main steps in drinking water purification:

The main operation employed in water purification to produce potable water are:
1. Sedimentation, 2. Filtration, and 3. Chlorination. Most microorganisms are removed during coagulation with aluminium sulphate and sand filtration and subsequent treatment of water with chlorine (0.2-1 mg free chloride per litre) will ensure its potability.

Flow diagram for water purification

Sedimentation -----> Raw water reservoir

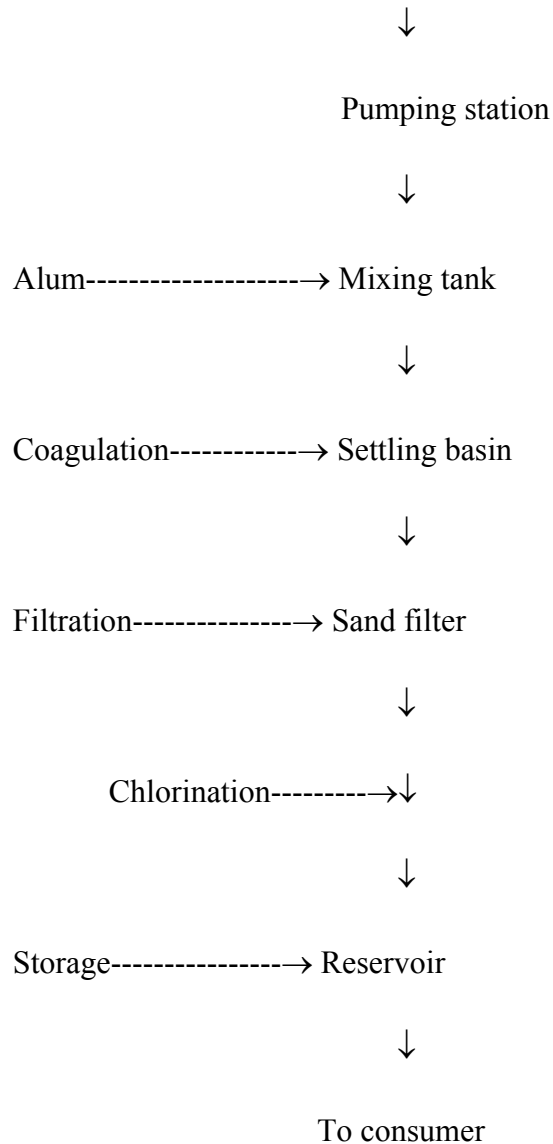

MICROBIOLOGICAL EXAMINATION OF WATER:

Water can be perfectly clear in appearance and free from odour and taste and yet, be contaminated by microorganisms. Pathogenic organisms enter into water through sewage contamination or discharges from animals or humans into the reservoirs. The coliforms (*E.coli* and related organisms) *Streptococcus faecalis* and *Clostridium perfringens* which are normal inhabitants of the large intestine of animals and humans enter water supplies through fecal contamination. The presence of any of these bacterial species in water is evidence of sewage or fecal pollution. Techniques are available by which the presence of these specific groups can be easily identified.

The routine bacteriological examination consists of

- (1) Plate count to determine the number of bacteria present and
- (2) Biochemical tests to reveal the presence of coliform bacteria.

A variety of other bacteria and organisms which may not be serious pathogens including fecal streptococci, slime forming bacteria, sulphur bacteria, algae etc. may also cause problems of odour, color and taste and it is essential that these are eliminated from the drinking water.

Tests for detection of coliforms:

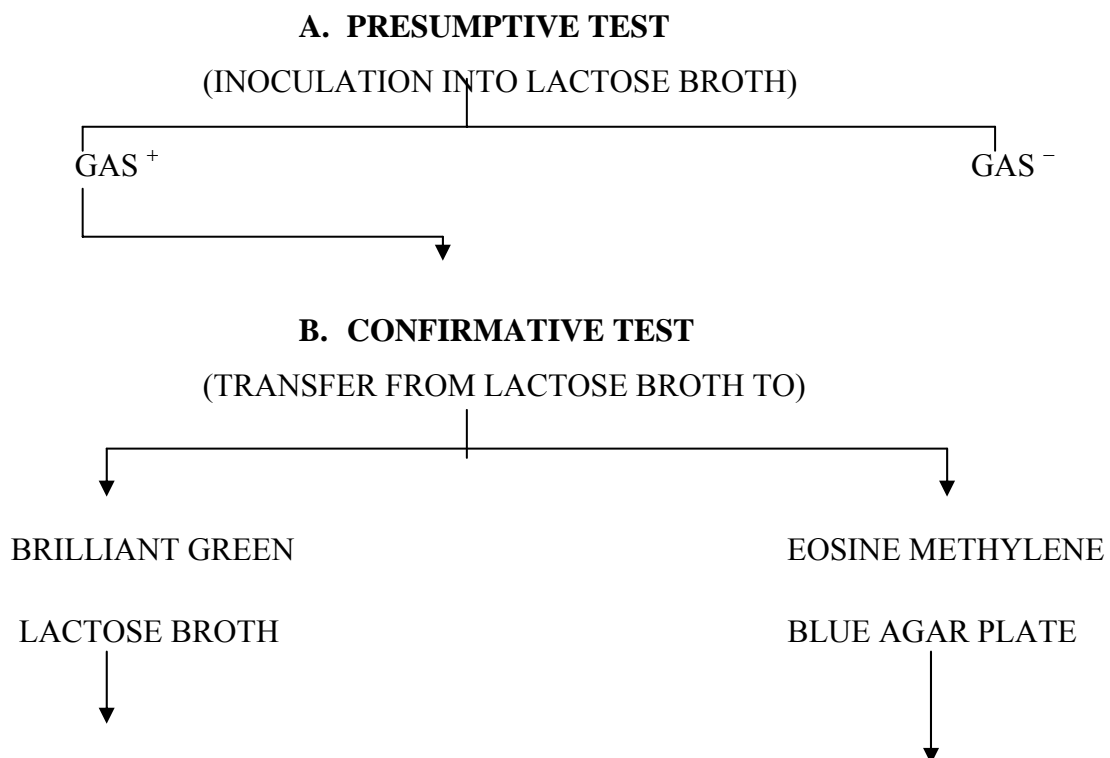

GAS⁺

Confirms the presence of coli forms Small black colonies with metallic Sheen (*E.coli*)

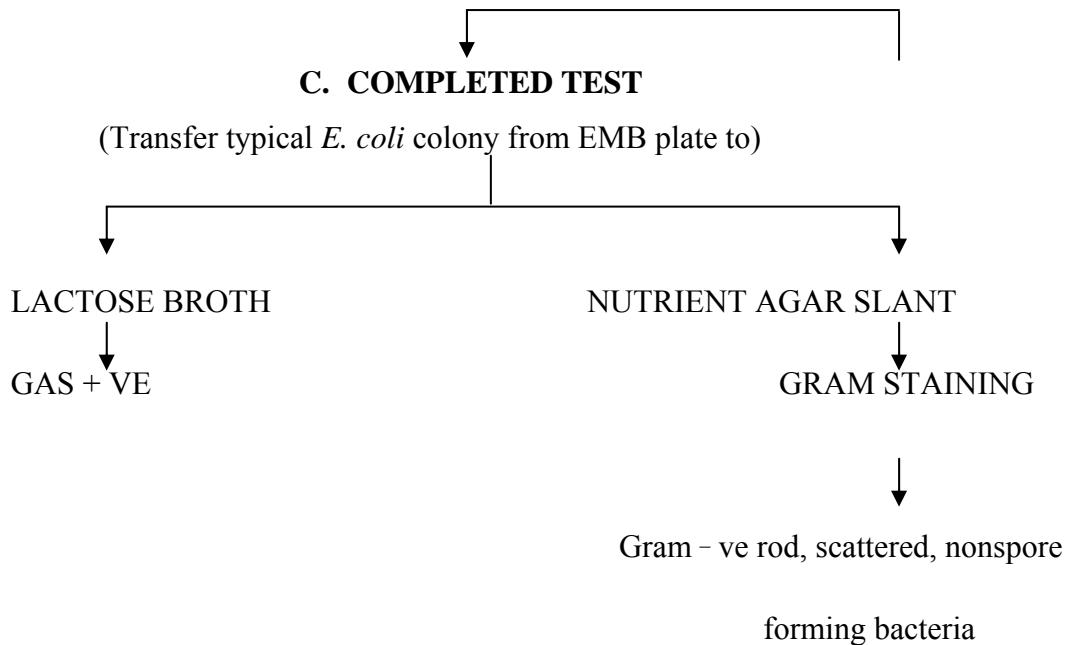

Lecture – 25

MICROBIOLOGY OF FOOD

Microorganisms are found everywhere in earth's atmosphere except in the inner tissues of healthy plant and animal tissues. Nearly all foods may be expected to contain microorganisms of one type or another. The existence of microorganisms at level of 10^3 to 10^5 per gram is common for many foods. Knowledge of the factors that favour or inhibit the growth of microorganisms is essential to an understanding of the principles of food spoilage and preservation. The chief compositional factors of a food that influence microbial activity are pH, moisture, Redox potential, nutrients and the presence of inhibitory substances or barriers. These are called intrinsic parameters. The parameters, which include storage temperature, relative humidity of environment, sanitary conditions etc. are considered as extreme parameters.

Intrinsic factors:

1. **pH:-** Most microbes grow best at pH values around 7.0. Fruits, soft drinks, vinegar and wines will have acidic pH at which the bacteria cannot grow. But the fruits will be spoiled by molds and yeasts, which can grow at value below 3.5

Most of the meats and sea foods have pH of 5.6 and above and hence these are susceptible to bacterial as well as mold and yeast spoilage. Most vegetables have higher pH values than fruits and consequently they are more subjected to bacterial than fungal spoilage.

2. **Water activity:-** Moisture is essential for the growth of microorganisms. It is now generally accepted that the water requirements of microorganisms should be defined in terms of water activity (a_w) in the environment. Water activity is defined as the ratio of the water vapour pressure of food substrate to the vapour pressure of pure water at the same temperature. Minimum a_w required for the growth of microorganisms in foods are given below.

<u>Organisms</u>	<u>Minimum a_w</u>
Most spoilage bacteria	0.91
Most spoilage yeasts	0.88
Most spoilage molds	0.80
Halophilic bacteria	0.75
Xerophilic molds	0.65

3. **Redox potential:**

The oxidation reduction potential of a system is expressed by the symbol Eh. The Eh values will be positive for the oxidized substances and negative for the reduced conditions (Eh of about – 200mv) for growth initiation, while the aerobic bacteria such as *Bacillus* require oxidized conditions i.e. positive Eh.

<u>Food</u>	<u>Eh values</u>
Plant juices	+300 to +400 mv
Solid meats	around –200 mv

4. Nutrient content:

In order to grow and function normally, the microorganisms that grow on food require the following:

- ✦ Source of energy,
- ✦ Source of nitrogen,
- ✦ Vitamins and related growth factors,
- ✦ Minerals.

5. Antimicrobial compounds:

The stability of some foods against attack by microorganisms is due to the presence in these foods of certain naturally occurring substances, which have been shown to have antimicrobial activities. For example lactenin and anticoliiform factor in milk and Lysozyme in egg white are antimicrobial.

6. Biological structures:

Natural structures as the testa of seeds, the outer covering of fruits, the shell of nuts and the shells of eggs protect them from entry and subsequent damage by the spoilage microorganisms.

Extrinsic factors:

1. Storage Temperature:

The lowest temperature at which a microorganism has been reported to grow is -34°C while the highest is somewhere in excess of 90°C . The psychrotrophs found most commonly on foods belong to the genera *Alcaligenes*, *Pseudomonas* and *Streptococcus*. These organisms grow well at refrigerated temperatures and cause spoilage to meats, fish, poultry, eggs and other foods normally held at this temperature. Most thermophilic bacteria that grow on foods belong to the genera *Bacillus* and *Clostridium*.

2. Relative Humidity of environment:

Foods that undergo surface spoilage from molds, yeasts and certain bacteria should be stored under conditions of low R.H.

The use of C-a storage for fruits is employed in number of countries. CO_2 has been shown to retard fungal rotting of fruits caused by large number of fungi.

Lecture No. 26

MICROBIAL SPOILAGE OF FOODS:

Different microorganisms involved in spoilage of foods:

Several genera of bacteria, molds and yeasts are associated with food spoilage.

Influence of nutrients, pH and water content on spoilage of fruits and vegetables:

From nutrient content of fruits & vegetables, the spoilage can occur from molds, yeast bacteria. The higher water content, and favourable pH range of most vegetables favours the growth of spoilage bacteria. *Erwinia* and *Pseudomonas* are the important among spoilage bacteria and among spoilage fungi the genus *Botrytis* is the predominant one.

The fruits differ from vegetables in having somewhat less water but more carbohydrates. However, the pH of fruits is found to be lower than that generally required for bacterial growth. This fact of unfavorable pH explains the general absence of bacteria in the incipient spoilage of fruits. The wider pH growth range of molds & yeasts suits them as spoilage agents. *Penicillium*, *Botrytis*, *Rhizopus*, *Aspergillus* etc. Are generally found to be associated with fruit spoilage.

Thus the composition and properties of vegetables & fruits may be successfully employed to predict the general type of their spoilage.

Spoilage of spices, nuts, pickles & other fermented foods:

Because of low water content of spices they rarely undergo microbial spoilage. Similar is the case with nuts, peanuts; whose water content is low and fat content is high. Molds growth is very common in nuts when they are stored in humid condition. Molds effected nuts are the major sources of aflatoxins. The pickles & other fermented foods usually undergo spoilage by molds

followed by bacteria when stored in humid condition. It is true with other fermented foods. Most of these foods pH is about

Lecture – 27

FOOD PRESERVATION

Food Preservation:

Salting, drying and smoking were the earlier methods of food preservation. Methods of preservation:

Principles of food preservation involves Aseptic handling, Inhibition of microbial growth, Reducing of microbial load and Killing of microbes in foods. Each step in the preparation of food for canning, freezing or dehydration is a potential source for contamination. Hence aseptic precautions must be observed. Using different physical and chemical agents it is possible to inhibit or reduce the growth of microbes and microbial load in foods. Ex. Reducing water activity. In some foods use of different methods involve total elimination of microbes by killing. Ex. Sterilization.

1. High temperatures include,
 - ✦ Blanching
 - ✦ Pasteurization
 - ✦ Boiling
 - ✦ Steam under pressure
 - ✦ Sterilization
2. Low temperatures:
 - ✦ Refrigeration
 - ✦ Freezing
3. Dehydration
4. Osmotic pressure:
 - ✦ In concentrated sugar
 - ✦ With brine
5. Radiation

6. Chemical preservatives
7. Pickling and fermented foods

1. High temperatures:

High temperature is one of the safest and most reliable methods of food preservation. Steam under pressure, such as in a pressure cooker, is the most effective method of high temperature food preservation, since it can kill all vegetative cells and spores. The temperatures used for canning foods ranges from 100°C for high acid foods to 121°C for low acid foods. The canning process does not guarantee a sterile product, as bacterial spores may survive these temperatures.

Commercial milk sterilization techniques have been developed which expose milk to ultrahigh temperatures for very short periods of time, for example, 300° F (148.9°C) for 1 or 2 seconds. The sterile milk has an indefinite shelf life.

Pasteurization of milk:

It is the process of heating every particle of milk at 145°F (62.8°C) for 30 minutes or to at least 161° F (71.7° C) for 15 seconds. In addition to milk numerous other food products and some fermented beverages like beers and wines are commercially pasteurized.

Blanching of leafy vegetables:

Immersing leafy vegetables in hot water before refrigeration is called blanching. Blanching helps in retaining the green color, prevents enzymic spoilage also.

2. Low temperature:

Temperatures approaching 0°C and lower retard the growth and metabolic activities of microorganisms. Before freezing the fresh food is steamed (blanched) to inactivate enzymes that would alter the product even at low temperatures. Quick freeze methods, using temperatures of -32°C or lower, are considered more satisfactory.

3. Dehydration

Dried foods have been used for centuries, and they are common through world than frozen foods. The removal of water by drying in the sun and air or with

applied heat causes dehydration. The preservative effect of dehydration is mainly due to microbistasis; the microorganisms are not necessarily killed. Growth of all microorganisms can be prevented by reducing the moisture content of their environment below a critical level.

4. Osmotic pressure

Water is withdrawn from microorganisms placed in solutions containing large amounts of dissolved substances such as sugar or salt. Preservation of foods by adding high salt concentration is known as pickling. Jams and jellies are rarely affected by bacteria because of high sugar content. Yeasts and molds are relatively resistant to osmotic changes.

5. Irradiation:

Ultraviolet light of sufficient intensity and time of exposure is microbicidal to exposed microorganisms. UV irradiation is limited to control microorganisms on surfaces, as it has very limited penetration.

Ionizing radiations such as Gamma rays and electron beams (Beta and cathode rays) are microbicidal at room temperature and have the ability to penetrate. Canned and packaged foods can be sterilized by an appropriate radiation dosage.

6. Addition of chemical preservatives

A chemical preservative must cause no chronic toxicity or accumulative effect to the consumer. The important chemical preservative which are considered to be safe and permitted to be used as preservatives are sodium or calcium propionate (bread) sodium benzoate (in fruit juices, other soft drinks), sorbic acid (citrus products), sulphur dioxide (dried fruits and vegetables), etc.

7. Pickling and fermentation of foods:

Preservation of foods by adding high salt concentration is known as pickling. The cells are plasmolised and the metabolism is arrested in pickling.

Foods prepared by fermentation processes are preserved mainly by acetic, lactic and propionic acids produced during the microbial fermentation. Microbes involved are Lactic acid bacteria like *Lactobacillus* and some yeasts.

Microbial processes have been used since prehistoric times and some of the traditional processes are production of beer, wine, vinegar, cheese and retting flax. With the understanding of role of microbes in these processes, it became possible to improve further and develop new processes for production of various organic chemicals useful for mankind.

Successful production of organic chemicals using microorganisms is dependent on several factors such as the organism, the raw materials and the cultural conditions. A desired end product is obtained in large quantities by utilizing a suitable microbe and a cheap raw material. The improvement of these processes is possible either by manipulating the cultural conditions of fermentation or addition of a few chemicals in the medium or by genetic manipulation of organisms including mutations and hybridization etc.

These microorganisms can be used in fermentations in different ways, batch, fed batch and continuous fermentations.

Batch fermentations:

In a batch cultures an organism is supplied with suitable raw material and cultural conditions. At the end of fermentation period the complete contents of fermentation vessel are used for extracting the end product. Therefore, the fermentation is carried out in batches.

Fed batch fermentations:

Also called as semi continuous fermentation. In this type intermittently substrate is added to fermentation tank. Eg. Biogas production

Continuous fermentations:

In this process, the culture is supplied with fermentation medium or raw materials continuously and from some point of time after starting of fermentation, the contents of fermentation tank are removed continuously. The important feature of continuous cultures is that the culture is continuously growing and a part of the culture is continuously removed along with the fermented medium. In the process, the volume of the contents in

the fermentation tank is maintained constant while extracting the desired end product from the fermented medium.

Based on the type of culturing the large-scale fermentations can be carried out by surface culture, submerged culture and solid-state method.

Surface culture:

In this method, an organism is allowed to grow on the surface of a liquid medium without agitation. At the end of the incubation period, the culture filtrate is separated and the cell mass is processed to obtain desired end product. This method is time consuming and needs large space. Ex: citric acid fermentation.

Submerged cultures:

In submerged culturing the organism is grown in a liquid medium with vigorous aeration and agitation. The fermentation vessels may be open or closed type based on the cultural conditions of fermentation. This culturing may be of batch type or continuous type. The fermenters are generally made of non-corrosive type of metal or glass lined or of wood. Most fermentation industries today use the submerged culture methods.

Solid state fermentations:

The culture medium is layered with a carrier such as wheat bran, potato pulp, etc. the suitable organism is allowed to grow on the medium, which provides a greater surface area for growth. The recovery of the end product is easier in this process. Ex. – Production of amylase using wheat bran, production of mushrooms etc.

List of products and microorganisms:

End Product	Microorganism involved
1.Organic acids: Acetic acid	 <i>Acetobacter</i> spp

Lactic acid	<i>L. delbrukii and other spp</i>
Citric acid	<i>Aspergillus niger , A. wentii</i>
2. Amino acids:	
Glutamic acid	<i>Brevibacterium spp</i>
Lysine	<i>Micrococcus glutamicus</i>
3. Vitamins:	
Cobalamin B12	<i>Streptomyces olivaceus</i> <i>Propionibacterium freudenreichii</i>
Riboflavin	<i>Eremothecium ashbyi</i>
4. Solvents:	
Acetone - butanol	<i>Clostridium acetobutylicum</i>
2,3- butane diol	<i>Enterobacter aerogenes</i>
5. Alcohol & Alcoholic beverages:	
Alcohol, bakers yeast, beer, wine, bread.	<i>Saccharomyces cerevisiae</i>

<p>6. Enzymes:</p> <p>Amylases</p> <p>Proteases</p> <p>Pectinase</p> <p>7. Steroid- transformations:</p> <p>11-α-hydroxy progesterone</p> <p>prednisolone</p> <p>8. Antibiotics:</p> <p>Penicillin</p> <p>Streptomycin</p> <p>Tetracycline</p> <p>Chloramphenicol</p> <p>Nystatin</p> <p>Erythromycin</p> <p>9. Microbial protein:</p> <p>Single cell protein</p>	<p><i>Aspergillus spp.</i></p> <p><i>Bacillus subtilis</i></p> <p><i>Aspergillus sp.</i></p> <p><i>Rhizopus nigricans</i></p> <p><i>Corynebacterium simplex</i></p> <p><i>Penicillium chrysogenum</i></p> <p><i>Streptomyces griseus</i></p> <p><i>Streptomyces aureofaciens</i></p> <p><i>Streptomyces venezulae</i></p> <p><i>Streptomyces nouresii</i></p> <p><i>Streptomyces erythreus</i></p> <p><i>Candida, Aspergillus, Saccharomyces,</i> <i>Scenedesmus. Pseudomonas,</i> <i>Cellulomonas,</i></p>
---	---

<p>10. Pharmacological products:</p> <p>Insulin, Interferon, Somatostatin, (human growth hormones)</p> <p>Streptokinase- streptodornase</p> <p>11. others:</p> <p>Bioinsecticides</p> <p>Biofertilisers</p> <p>Gibberllic acid</p>	<p><i>Recombinant DNA varieties of E.coli.</i></p> <p><i>Streptococcus equisimils</i></p> <p>Bacillus thuringiensis, B. popilliae</p> <p>Rhizobium, Azotobacter, <i>Blue green algae (BGA).</i></p> <p><i>Gibberella fujikuroi</i></p>
--	---

Lecture – 29

BENEFICIAL MICROORGANISMS IN AGRICULTURE

Biofertilizers or Bioinoculants are preparations containing living microorganisms such as nitrogen fixers or phosphate solubilizers, which are useful for agricultural production.

Bacterial biofertilisers:

Since most of the pulse crops are grown without supply of inorganic nitrogen (chemical) fertilizers, their growth is dependent on the supply of combined nitrogen by nitrogen fixing bacteria. Rhizobial inoculants production involves isolation of efficient

strains of Rhizobia, culturing of strains specific for a particular crop in shake flasks or fermentors and mixing of peat. The mixture is allowed to be cured for a short period and then packed in sterile polythene bags. The packets are then used for inoculating the seeds before sowing. *Azotobacter* and *Azospirillum* inoculants are also produced on the same principle and used for non leguminous crops.

Cyanobacterial Biofertilisers:

The Blue green algae are also being produced on large scale and used as biofertilizers in rice cultivation. The efficient strains are cultured in open plots with water containing adequate amounts of mineral nutrients such as phosphate and molybdate. After sufficient growth is obtained, the algal mat is collected from the plot, dried and used as inoculant. Cyanobacteria can also be grown directly in the paddy field before the transplantation of rice plants. Azolla, a symbiotic association of a small fern with blue green algae is also used as a biofertilizer and green manure for rice cultivation.

Fungal biofertilisers:

Some fungi grow in association with roots of plants. Vesicular aurbascular Mycorrhizae help in supplying of phosphorus to the crop plants in addition to helping the plant in different ways. VAM fungi like *Glomus*, *Gigaspora* etc. are used as fungal biofertilisers.

List of Bacteria, Cyanobacteria and fungi used in bioinoculants:

Microorganism	Beneficial plants
1. <i>Rhizobium spp</i> (symbiotic N ₂ fixer)	All grain legumes, oil legumes, fodder legumes.
2. <i>Azotobacter spp</i> (free living N ₂ fixer)	All crops especially vegetables and other commercial crops.

3. <i>Azospirillum</i> (associative N ₂ fixers)	Maize, sorghum, and millets etc.
4. Blue green algae (free living N ₂ fixer) <i>Nostoc, Anabena, etc</i>	Irrigated rice
5. <i>Azolla</i> (symbiotic N ₂ fixer) Fern + cyanobacteria	Rice fields
6. <i>Mycorrhizae</i> (symbiotic P solubilizer) plant roots +fungus	Can be used for all most all crops.
7. <i>Phosphobacterium,</i> <i>Bacillus megaterium</i>	For all crops

Advantages and disadvantages:

The advantages in usage of biofertilizers is that the use of biofertilizers does not create any pollution problems commonly found with excessive use of chemical fertilizers and the production of biofertilizers is cheaper than the chemical fertilizers. The effectiveness of biofertilizers mainly depend on the use of effectiveness of biofertilizers mainly depend on the use of effective strains, proper precautions in storage and seed inoculation.

Rhizobium - host specificity:

The rhizobia show host specificity to some extent in other words , Rhizobia isolated from ground nut cannot be used for red gram. Rhizobium has the ability to form nodules only on roots of a limited and related plant species . Based on this property , rhizobia are classified into seven cross- inoculation groups.

CROSS INOCULATION GROUPS OF RHIZOBIA

Group	Rhizobia	Host range
-------	----------	------------

1. Alfalfa group	<i>R. meliloti</i>	<i>Medicago, Melilotus, Trigonella.</i>
2. Clover group	<i>R. trifoli</i>	<i>Clovers.</i>
3. Pea group	<i>R. leguminosarum</i>	<i>Pisum, Vicia, Lens</i>
4. Bean group	<i>R. phaseoli</i>	<i>Phaseolus.</i>
5. Lupine group	<i>R. lupini</i>	<i>Lupinus, Ornithopus.</i>
6. Soybean group	<i>R. japonicum</i>	<i>Glycine.</i>
7. Cowpea group	“Cowpea –rhizobia”	<i>Vigna, Arachis, Phaseolus, Cajanus, Dolichos etc.</i>

The rhizobia which can form nodules on the related plant have been collectively taken as a species.

Steps in Rhizobium inoculants production:

- **Selection of efficient strain:**
 1. Compete with native rhizobia
 2. Form good number of nodules
 3. High nitrogen fixation ability
- **Inoculation into sterile fermentation medium:**
- **Maintaining optimal conditions for growth (pH, temp etc.)**
- **Mixing log phase culture with sterile , neutralized Lignite/peat**
- **Packing in 0.04 to 0.05mm sterile polythene bags**

- **Information on**
- Expiry of the product, storage conditions and Crop details should be indicated

Lecture - 30

MICROBIAL INSECTICIDES

Many microorganisms such as mycoplasma, bacteria, fungi and protozoa are pathogenic to insects. **Microbial preparations and formulations in the insect pest control programme are known as microbial insecticides.**

List of different microbial insecticides and their host range are given below

Microbial insecticide	Host range
<p>1. Bacterial insecticides:</p> <p>a) <i>Bacillus thuringiensis</i></p> <p>b) <i>Bacillus popillae</i></p> <p>c) <i>Bacillus sphaericus</i></p> <p>2. Fungal insecticides:</p> <p>a) <i>Beauveria bassiana</i></p> <p>b) <i>Metarrhizium anisopliae</i></p> <p>3. Protozoal insecticides:</p> <p>a) <i>Nosema locustae</i></p> <p>Viral insecticides:</p> <p><i>Nuclear polyhedrosis viruses</i></p>	<p>Silkworm, Cabbageworm, Sweet potato, Leaf worm, Tobacco cutworm, Rice leaf roller etc.</p> <p>Japanese beetle, which causes damage to number of trees and shrubs.</p> <p>Mosquitoes.</p> <p>Potato beetle.</p> <p>Rhinoceros beetle, Black rice bug.</p> <p>Grasshoppers and several species of crickets.</p> <p>Tobacco budworm, Cotton bollworm</p>

ADVANTAGES:

1. They do not cause pollution hence they are ecofriendly
2. They are more specific and hence do not affect beneficial insects

DISADVANTAGES:

1. Immediate effect is not seen owing to the incubation period of the microorganisms in the body of insect.
2. The narrow host range of microbial insecticides is disadvantageous in practical insect pest control.
3. The contact infection occurs only in the case of fungal infections and in the case of others, insects should necessarily ingest leaves, coated with microbial insecticide before being infected

Microbial insecticide preparations of bacteria, protozoa, and virus are available in the form of dusts, wettable powders and water dispersible emulsions.

Lecture. 31

MICROBIAL BIOCONTROL

Microbial biocontrol:

Microorganisms or their products (toxins) are employed by man for the control of insects, animal and plant pathogens, weeds, etc. referred as microbial biocontrol.

This may involve the use of microbial inoculants to suppress a single type or class of plant diseases. Or, this may involve managing soils to promote the combined activities of native soil- and plant-associated microorganisms that contribute to general suppression. Most narrowly, biological control refers to the suppression of a single pathogen (or pest), by a single antagonist, in a single cropping system.

INTERACTIONS INVOLVED IN BIOCONTROL MECHANISMS

From the plant's perspective, biological control can be considered a net positive result arising from a variety of specific and non-specific interactions. The types of interactions are referred as parasitism, antagonism, competition, and predation etc.

Parasitism is a symbiosis in which two phylogenetically unrelated microorganisms coexist over a prolonged period of time. In this type of association, one organism, usually the physically smaller of the two (called the parasite) benefits and the other (called the host) is harmed to some measurable extent. The activities of various hyperparasites, i.e., those agents that parasitize plant pathogens, can result in biocontrol. And, interestingly, host infection and parasitism by relatively avirulent pathogens may lead to biocontrol of more virulent pathogens through the stimulation of host defense system.

Antagonism (ammensalism) one microorganism produces a substance that is inhibitory to other microbial population results in a negative outcome for later one. Production of oxygen may alter the population of obligate aerobes. Ammonia produced during decompositions of proteins and amino acids at concentrations inhibitory to nitrite oxidizing populations of *Nitrobacter*.

Competition within and between species results in decreased growth, activity and/or fecundity of the interacting microorganisms. For example biocontrol can occur when non-pathogens compete with pathogens for nutrients in and around the host plant.

Predation refers to the killing of one microorganism by another for consumption and sustenance. While the term predator typically refer to animals that feed at higher trophic levels in the macroscopic world, it has also been applied to the actions of microbes, e.g. protists, and mesofauna, e.g. fungal feeding nematodes and microarthropods, that consume pathogen biomass for sustenance. E.g. *Dinidium nasutum* preys on *Paramecium*

Biological control can result in varying degrees from all of these types of interactions, depending on the environmental context within which they occur. Significant biological control, as defined above, most generally arises from manipulating mutualism between microbes and their plant hosts or from manipulating antagonism between microbes and pathogens.

ADVANTAGES

- Environment friendly and leave behind no toxic residues.
- Target specific pathogen and avoids unnecessary affect on beneficial microflora and microfauna.
- Most of them are easily culturable in the lab, with minimum space.
- Inexpensive to produce large quantities of inoculum.
- Its mimicry of nature by releasing them into an open environment.
- Biological control could reduce the use of many pesticides and herbicides hence, which could eliminate the overuse of chemicals by farmers and further reduces cost of cultivation.

DISADVANTAGES

- Necessity for careful and correct time of application.
- Host specificity of most pathogens, narrows down its use.
- Necessity to maintain a pathogen in a viable condition.

- Difficulty in producing some obligate and facultative pathogens on a large scale.
- Requirement of favourable environmental conditions for the pathogens to act, multiply and execute its mode of action.
- Potential biological control agents need to be subjected to extensive testing and quarantine before release into any new environment.

APPLICATIONS

Control of plant diseases.

- 1) *Bacillus cereus* strains –produce the antibiotic zwittermicin –protect tomato and alf-alfa plants from various soil born fungi –*Phytophthora* and *Pythium*
- 2) *P. fluorescens*, prevents bacterial blotch by competing with *P. tolaasii*
- 3) *Trichoderma viridae*: against Root Rot, Stem Rot, Wilt, Lead Spot, Early & Late Blights, Tikka Disease, Downy Mildews, etc. of different crop plants.

Lecture -32

BIODEGRADATION

Microbial conversion of waste materials such as agricultural, industrial and domestic wastes, by microorganisms into inorganic compounds is called biodegradation.

For successful survival of mankind on earth, recycling of organic and inorganic materials is essential. Microorganisms degrade various organic wastes by various biochemical processes and purify them to a stage of reutilization. The biogas production has gained importance in view of developing alternate sources of energy. The environmental conditions in our country are very suitable for the production of biogas.

Composition of Biogas:

Biogas is a mixture of methane (50-60%), carbon dioxide (30-40 %), hydrogen (5-10 %), H₂S and nitrogen (traces), produced from the anaerobic digestion of animal, plant wastes or any cellulose containing waste material.

Microbiology of biogas production:

The digester used for biogas production is called a biogas plant. A typical biogas plant using cow dung as raw material consists of a) digester and b) gas holder. The digester is of continuous type, which is fed with a definite quantity of wastes at regular intervals so that gas production is continuous and regular. The nature of fermentation in digester is anaerobic.

There are three phases in the anaerobic fermentation of organic matter to methane.

1. The hydrolytic bacteria, which catabolize carbohydrates, proteins, lipids other components of biomass to fatty acids, H₂ and CO₂.
2. The acidogenic bacteria which catabolize certain fatty acids and natural end products of group one to volatile fatty acids like propionate, acetate, formate, carbon dioxide, and hydrogen.
3. The methanogenic bacteria which utilize acetate, CO₂ and H₂ to produce methane

The hydrolytic and acidogenic groups of bacteria include facultative as well as strict anaerobes like *Cellulomonas*, *Clostridium*, *Bacillus*, *Bacteroids*, *Ruminococcus*, *Eubacterium* etc. While the methanogenic bacteria includes *Methanosarcina*, *Methanothrix*, *Methanobacterium* and *Methanospirillum*.

The methanogenic phase is strictly anaerobic and during this phase organic carbon is converted into microbial mass, CO₂ and methane. These bacteria are sensitive to pH and the optimal pH for the methane production is 6.8 to 7.2. If pH drops to 6.6 or below there is an inhibition of methanogenesis.

Biogas manures:

The material after fermentation and production of biogas are called as biogas manures and they can be used as manures to different crops.

**B.Sc. Ag
II Sem**

Agricultural Microbiology

Credit - 2(1+1)

**As per ICAR
5TH Dean Syllabus**

**Download all BSc
Agriculture Notes from**
(Search on Google)

Bscagriculture.com